



HEADQUARTERS
ARMED FORCES OF THE PHILIPPINES BIDS AND AWARDS COMMITTEE
OFFICE OF THE PHILIPPINE ARMY BIDS AND AWARDS COMMITTEE 1
Fort Andres Bonifacio, Metro Manila

BIDDING DOCUMENTS

for the

**Procurement of 71,018 pairs
Army Combat Boots, Suede, Field Use**

QM PABAC1 002-24

ABC: Php198,850,400.00

Table of Contents

Glossary of Acronyms, Terms, and Abbreviations	2
Section I. Invitation to Bid.....	5
Section II. Instructions to Bidders.....	8
1. Scope of Bid	8
2. Funding Information.....	8
3. Bidding Requirements	8
4. Corrupt, Fraudulent, Collusive, and Coercive Practices	8
5. Eligible Bidders.....	8
6. Origin of Goods	9
7. Subcontracts	9
8. Pre-Bid Conference	9
9. Clarification and Amendment of Bidding Documents	9
10. Documents comprising the Bid: Eligibility and Technical Components	10
11. Documents comprising the Bid: Financial Component	10
12. Bid Prices	10
13. Bid and Payment Currencies	11
14. Bid Security	11
15. Sealing and Marking of Bids	11
16. Deadline for Submission of Bids	12
17. Opening and Preliminary Examination of Bids	12
18. Domestic Preference	12
19. Detailed Evaluation and Comparison of Bids	12
20. Post-Qualification	13
21. Signing of the Contract	13
Section III. Bid Data Sheet	14
Section IV. General Conditions of Contract.....	17
1. Scope of Contract	18
2. Advance Payment and Terms of Payment	18
3. Performance Security	18
4. Inspection and Tests	18
5. Warranty	19
6. Liability of the Supplier	19
Section V. Special Conditions of Contract	20
Section VI. Schedule of Requirements	27
Section VII. Technical Specifications	28
Section VIII. Checklist of Technical and Financial Documents	44

Glossary of Acronyms, Terms, and Abbreviations

ABC – Approved Budget for the Contract.

BAC – Bids and Awards Committee.

Bid – A signed offer or proposal to undertake a contract submitted by a bidder in response to and in consonance with the requirements of the bidding documents. Also referred to as *Proposal* and *Tender*. (2016 revised IRR, Section 5[c])

Bidder – Refers to a contractor, manufacturer, supplier, distributor and/or consultant who submits a bid in response to the requirements of the Bidding Documents. (2016 revised IRR, Section 5[d])

Bidding Documents – The documents issued by the Procuring Entity as the bases for bids, furnishing all information necessary for a prospective bidder to prepare a bid for the Goods, Infrastructure Projects, and/or Consulting Services required by the Procuring Entity. (2016 revised IRR, Section 5[e])

BIR – Bureau of Internal Revenue.

BSP – Bangko Sentralng Pilipinas.

Consulting Services – Refer to services for Infrastructure Projects and other types of projects or activities of the GOP requiring adequate external technical and professional expertise that are beyond the capability and/or capacity of the GOP to undertake such as, but not limited to: (i) advisory and review services; (ii) pre-investment or feasibility studies; (iii) design; (iv) construction supervision; (v) management and related services; and (vi) other technical services or special studies. (2016 revised IRR, Section 5[i])

CDA - Cooperative Development Authority.

Contract – Refers to the agreement entered into between the Procuring Entity and the Supplier or Manufacturer or Distributor or Service Provider for procurement of Goods and Services; Contractor for Procurement of Infrastructure Projects; or Consultant or Consulting Firm for Procurement of Consulting Services; as the case may be, as recorded in the Contract Form signed by the parties, including all attachments and appendices thereto and all documents incorporated by reference therein.

CIF – Cost Insurance and Freight.

CIP – Carriage and Insurance Paid.

CPI – Consumer Price Index.

DDP – Refers to the quoted price of the Goods, which means “delivered duty paid.”

DTI – Department of Trade and Industry.

EXW – Ex works.

FCA – “Free Carrier” shipping point.

FOB – “Free on Board” shipping point.

Foreign-funded Procurement or Foreign-Assisted Project–Refers to procurement whose funding source is from a foreign government, foreign or international financing institution as specified in the Treaty or International or Executive Agreement. (2016 revised IRR, Section 5[b]).

Framework Agreement – Refers to a written agreement between a procuring entity and a supplier or service provider that identifies the terms and conditions, under which specific purchases, otherwise known as “Call-Offs,” are made for the duration of the agreement. It is in the nature of an option contract between the procuring entity and the bidder(s) granting the procuring entity the option to either place an order for any of the goods or services identified in the Framework Agreement List or not buy at all, within a minimum period of one (1) year to a maximum period of three (3) years. (GPPB Resolution No. 27-2019)

GFI – Government Financial Institution.

GOCC –Government-owned and/or –controlled corporation.

Goods – Refer to all items, supplies, materials and general support services, except Consulting Services and Infrastructure Projects, which may be needed in the transaction of public businesses or in the pursuit of any government undertaking, project or activity, whether in the nature of equipment, furniture, stationery, materials for construction, or personal property of any kind, including non-personal or contractual services such as the repair and maintenance of equipment and furniture, as well as trucking, hauling, janitorial, security, and related or analogous services, as well as procurement of materials and supplies provided by the Procuring Entity for such services. The term “related” or “analogous services” shall include, but is not limited to, lease or purchase of office space, media advertisements, health maintenance services, and other services essential to the operation of the Procuring Entity. (2016 revised IRR, Section 5[r])

GOP – Government of the Philippines.

GPPB –Government Procurement Policy Board.

INCOTERMS – International Commercial Terms.

Infrastructure Projects – Include the construction, improvement, rehabilitation, demolition, repair, restoration or maintenance of roads and bridges, railways, airports, seaports, communication facilities, civil works components of information technology projects, irrigation, flood control and drainage, water supply, sanitation, sewerage and solid waste management systems, shore protection, energy/power and electrification facilities, national

buildings, school buildings, hospital buildings, and other related construction projects of the government. Also referred to as *civil works or works*. (2016 revised IRR, Section 5[u])

LGUs – Local Government Units.

NFCC – Net Financial Contracting Capacity.

NGA – National Government Agency.

PhilGEPS - Philippine Government Electronic Procurement System.

Procurement Project – refers to a specific or identified procurement covering goods, infrastructure project or consulting services. A Procurement Project shall be described, detailed, and scheduled in the Project Procurement Management Plan prepared by the agency which shall be consolidated in the procuring entity's Annual Procurement Plan. (GPPB Circular No. 06-2019 dated 17 July 2019)

PSA – Philippine Statistics Authority.

SEC – Securities and Exchange Commission.

SLCC – Single Largest Completed Contract.

Supplier – refers to a citizen, or any corporate body or commercial company duly organized and registered under the laws where it is established, habitually established in business and engaged in the manufacture or sale of the merchandise or performance of the general services covered by his bid. (Item 3.8 of GPPB Resolution No. 13-2019, dated 23 May 2019). Supplier as used in these Bidding Documents may likewise refer to a distributor, manufacturer, contractor, or consultant.

UN – United Nations.

Section I. Invitation to Bid

HEADQUARTERS
ARMED FORCES OF THE PHILIPPINES BIDS AND AWARDS COMMITTEE
OFFICE OF THE PHILIPPINE ARMY BIDS AND AWARDS COMMITTEE 1
Fort Andres Bonifacio, Metro Manila

INVITATION TO BID FOR THE PROCUREMENT OF 71,018 PAIRS ARMY COMBAT BOOTS, SUEDE, FIELD USE

1. The Philippine Army, through the Philippine Army Appropriation CY 2024 with OG10 Certification dated 24 July 2023 valid until 31 December 2024, intends to apply the sum of **One Hundred Ninety-Eight Million Eight Hundred Fifty Thousand Four Hundred Pesos (Php198,850,400.00)** being the ABC to payments under the contract for the Procurement of 71,018 pairs Army Combat Boots, Suede, Field Use under QM PABAC1 002-24. Bids received in excess of the ABC shall be automatically rejected at bid opening.
2. The Philippine Army now invites bids for the above Procurement Project. Delivery of the Goods is required **One Hundred Sixty (160) calendar days** from the receipt of Notice to Proceed (NTP) by the supplier, which date shall not be later than seven (7) days from the issuance of NTP. Bidders should have completed, within five (5) years from the date of submission and receipt of bids, a contract similar to the Project. The description of an eligible bidder is contained in the Bidding Documents, particularly, in Section II (Instructions to Bidders).
3. Bidding will be conducted through open competitive bidding procedures using a non-discretionary “*pass/fail*” criterion as specified in the 2016 revised Implementing Rules and Regulations (IRR) of Republic Act (RA) No. 9184.

Bidding is open **only** to **all local shoe manufacturers** as prescribed under RA No. 9290 and its IRR and further subject to the conditions for eligibility provided in the 2016 revised IRR of RA No. 9184.

4. Prospective Bidders may obtain further information from the Philippine Army and inspect the Bidding Documents at the address given below office hours (8:00AM to 4:00PM) on weekdays only (except holidays).
5. A complete set of Bidding Documents may be acquired by interested Bidders on _____ from the given address and website(s) below and upon payment of the applicable fee for the Bidding Documents, pursuant to the latest Guidelines issued by the GPPB in the amount of Fifty Thousand Pesos (Php50,000.00). The Procuring Entity shall allow the bidder to present its proof of payment for the fees in person, by facsimile, or through electronic means.
6. The Philippine Army through PABAC1 will hold a Pre-Bid Conference on the time and date as specified below at the Office of the PABAC1, Fort Andres Bonifacio, Taguig,

City and/or through video conferencing or webcasting via Zoom, which shall be open to prospective bidders. Only One (1) representative per bidder will be accommodated on the venue. Other representatives will attend through VTC. Zoom link will be provided one hour before the start of the PRE-BID Conference

7. Bids must be duly received by the BAC Secretariat through manual submission at the office address indicated below, on or before the date of submission. Late bids shall not be accepted.
8. All Bids must be accompanied by a bid security in any of the acceptable forms and in the amount stated in **ITB** Clause 14.
9. Bid opening shall be on the date as specified below and at the given address below and/or through video conferencing or webcasting. Bids will be opened in the presence of the bidders' representatives who choose to attend the activity.

The schedule of the bidding activities shall be as follows:

ACTIVITIES	TIME and DATE	VENUE
1. Sale and Issuance of Bidding Documents	8:00AM to 4:00PM Mondays to Fridays only starting on Sep 7, 2023	Office of the PABAC1, Fort Andres Bonifacio, Taguig City
2. Pre-Bid Conference	14 Sept 2023 (Thursday)	
3. Submission of Bids	On or before 28 1:30PM Sept 2024 (Thursday)	
4. Opening of Bids	28 1:30PM Sept 2024 onwards	

10. The Philippine Army reserves the right to reject any and all bids, declare a failure of bidding, or not award the contract at any time prior to contract award in accordance with Sections 35.6 and 41 of the 2016 revised IRR of RA No. 9184, without thereby incurring any liability to the affected bidder or bidders.

Tie breaking method shall be non-discretionary and non-discriminatory. The same shall be based on sheer luck or chance (Toss Coin) and in chronological order based on the submission of bids.

11. For further information, please refer to:

Office of the PA Bids and Awards Committee 1
Fort Andres Bonifacio, Taguig City

BGEN ANTONIO C ROTA JR PA

PABAC1 Chairperson

Contact Nr. +63999-321-1164/+63977-488-0012

Telephone Nr. 845-9555 local 6891

Email address: pabacsec@gmail.com

12. You may visit the following websites:

For downloading of Bidding Documents:

- *philgeps.gov.ph*
- *army.mil.ph*

Date of issue: _____

BGEN ANTONIO C ROTA JR PA
PABAC1 Chairperson

Section II. Instructions to Bidders

1. Scope of Bid

The Procuring Entity, Philippine Army wishes to receive Bids for the **Procurement of 71,018 pairs Army Combat Boots, Suede, Field Use under QM PABAC1 002-24.**

The Procurement Project (referred to herein as “Project”) is composed of **one lot**, the details of which are described in Section VII (Technical Specifications).

2. Funding Information

2.1. The GOP through the source of funding as indicated below for 2023 in the amount of **One Hundred Ninety-Eight Million Eight Hundred Fifty Thousand Four Hundred Pesos (Php198,850,400.00).**

2.2. The source of funding is: National Expenditure Program CY 2024.

3. Bidding Requirements

The Bidding for the Project shall be governed by all the provisions of RA No. 9184 and its 2016 revised IRR, including its Generic Procurement Manuals and associated policies, rules and regulations as the primary source thereof, while the herein clauses shall serve as the secondary source thereof.

Any amendments made to the IRR and other GPPB issuances shall be applicable only to the ongoing posting, advertisement, or **IB** by the BAC through the issuance of a supplemental or bid bulletin.

The Bidder, by the act of submitting its Bid, shall be deemed to have verified and accepted the general requirements of this Project, including other factors that may affect the cost, duration and execution or implementation of the contract, project, or work and examine all instructions, forms, terms, and project requirements in the Bidding Documents.

4. Corrupt, Fraudulent, Collusive, and Coercive Practices

The Procuring Entity, as well as the Bidders and Suppliers, shall observe the highest standard of ethics during the procurement and execution of the contract. They or through an agent shall not engage in corrupt, fraudulent, collusive, coercive, and obstructive practices defined under Annex “I” of the 2016 revised IRR of RA No. 9184 or other integrity violations in competing for the Project.

5. Eligible Bidders

5.1. Only Bids of Bidders found to be legally, technically, and financially capable will be evaluated.

- 5.2. Foreign ownership exceeding those allowed under the rules may participate pursuant to:
 - i. When a Treaty or International or Executive Agreement as provided in Section 4 of the RA No. 9184 and its 2016 revised IRR allow foreign bidders to participate;
 - ii. Citizens, corporations, or associations of a country, included in the list issued by the GPPB, the laws or regulations of which grant reciprocal rights or privileges to citizens, corporations, or associations of the Philippines;
 - iii. When the Goods sought to be procured are not available from local suppliers; or
 - iv. When there is a need to prevent situations that defeat competition or restrain trade.
- 5.3. Pursuant to Section 23.4.1.3 of the 2016 revised IRR of RA No.9184, the Bidder shall have an SLCC that is at least one (1) contract similar to the Project the value of which, adjusted to current prices using the PSA's CPI, must be at least equivalent to at least twenty-five percent (25%) of the ABC (Expendable Supplies)
- 5.4. The Bidders shall comply with the eligibility criteria under Section 23.4.1 of the 2016 IRR of RA No. 9184.

6. Origin of Goods

There is no restriction on the origin of goods other than those prohibited by a decision of the UN Security Council taken under Chapter VII of the Charter of the UN, subject to Domestic Preference requirements under **ITB** Clause 18.

7. Subcontracts

7.1. The Procuring Entity has prescribed that: **Subcontracted is now allowed.**

8. Pre-Bid Conference

The Procuring Entity will hold a pre-bid conference for this Project on the specified date and time and either at its physical address and/or through videoconferencing/webcasting as indicated in paragraph 6 of the **IB**.

9. Clarification and Amendment of Bidding Documents

Prospective bidders may request for clarification on and/or interpretation of any part of the Bidding Documents. Such requests must be in writing and received by the Procuring Entity, either at its given address or through electronic mail indicated in the **IB**, at least ten (10) calendar days before the deadline set for the submission and receipt of Bids.

10. Documents comprising the Bid: Eligibility and Technical Components

- 10.1. The first envelope shall contain the eligibility and technical documents of the Bid as specified in **Section VIII (Checklist of Technical and Financial Documents)**.
- 10.2. The Bidder's SLCC as indicated in **ITB Clause 5.3** should have been completed within five (5) years prior to the deadline for the submission and receipt of bids.
- 10.3. If the eligibility requirements or statements, the bids, and all other documents for submission to the BAC are in foreign language other than English, it must be accompanied by a translation in English, which shall be authenticated by the appropriate Philippine foreign service establishment, post, or the equivalent office having jurisdiction over the foreign bidder's affairs in the Philippines. Similar to the required authentication above, for Contracting Parties to the Apostille Convention, only the translated documents shall be authenticated through an apostille pursuant to GPPB Resolution No. 13-2019 dated 23 May 2019. The English translation shall govern, for purposes of interpretation of the bid.

11. Documents comprising the Bid: Financial Component

- 11.1. The second bid envelope shall contain the financial documents for the Bid as specified in **Section VIII (Checklist of Technical and Financial Documents)**.
- 11.2. If the Bidder claims preference as a Domestic Bidder or Domestic Entity, a certification issued by DTI shall be provided by the Bidder in accordance with Section 43.1.3 of the 2016 revised IRR of RA No. 9184.
- 11.3. Any bid exceeding the ABC indicated in paragraph 1 of the **IB** shall not be accepted.
- 11.4. For Foreign-funded Procurement, a ceiling may be applied to bid prices provided the conditions are met under Section 31.2 of the 2016 revised IRR of RA No. 9184.

12. Bid Prices

- 12.1. Prices indicated on the Price Schedule shall be entered separately in the following manner:
 - a. For Goods offered from within the Procuring Entity's country:
 - i. The price of the Goods quoted EXW (ex-works, ex-factory, ex-warehouse, ex-showroom, or off-the-shelf, as applicable);
 - ii. The cost of all customs duties and sales and other taxes already paid or payable;

- iii. The cost of transportation, insurance, and other costs incidental to delivery of the Goods to their final destination; and
 - iv. The price of other (incidental) services, if any, listed in e.
- b. For Goods offered from abroad:
- i. Unless otherwise stated in the **BDS**, the price of the Goods shall be quoted delivered duty paid (DDP) with the place of destination in the Philippines as specified in the **BDS**. In quoting the price, the Bidder shall be free to use transportation through carriers registered in any eligible country. Similarly, the Bidder may obtain insurance services from any eligible source country.
 - ii. The price of other (incidental) services, if any, as listed in **Section VII (Technical Specifications)**.

13. Bid and Payment Currencies

- 13.1. For Goods that the Bidder will supply from outside the Philippines, the bid prices may be quoted in the local currency or tradeable currency accepted by the BSP at the discretion of the Bidder. However, for purposes of bid evaluation, Bids denominated in foreign currencies, shall be converted to Philippine currency based on the exchange rate as published in the BSP reference rate bulletin on the day of the bid opening.
- 13.2. Payment of the contract price shall be made in: **Philippine Pesos**.

14. Bid Security

- 14.1. The Bidder shall submit a Bid Securing Declaration or any form of Bid Security in the amount indicated in the **BDS**, which shall be not less than the percentage of the ABC in accordance with the schedule in the **BDS**.
- 14.2. The Bid and bid security shall be valid within one hundred twenty (120) calendar days from the date of the opening of bids. Any Bid not accompanied by an acceptable bid security shall be rejected by the Procuring Entity as non-responsive.

15. Sealing and Marking of Bids

Each Bidder shall submit one copy of the first and second components of its Bid.

The Procuring Entity may request additional hard copies and/or electronic copies of the Bid. However, failure of the Bidders to comply with the said request shall not be a ground for disqualification.

If the Procuring Entity allows the submission of bids through online submission or any other electronic means, the Bidder shall submit an electronic copy of its Bid, which

must be digitally signed. An electronic copy that cannot be opened or is corrupted shall be considered non-responsive and, thus, automatically disqualified.

16. Deadline for Submission of Bids

- 16.1. The Bidders shall submit on the specified date and time and either at its physical address or through online submission as indicated in paragraph 7 of the **IB**.

17. Opening and Preliminary Examination of Bids

- 17.1. The BAC shall open the Bids in public at the time, on the date, and at the place specified in paragraph 9 of the **IB**. The Bidders' representatives who are present shall sign a register evidencing their attendance. In case videoconferencing, webcasting or other similar technologies will be used, attendance of participants shall likewise be recorded by the BAC Secretariat.

In case the Bids cannot be opened as scheduled due to justifiable reasons, the rescheduling requirements under Section 29 of the 2016 revised IRR of RA No. 9184 shall prevail.

- 17.2. The preliminary examination of bids shall be governed by Section 30 of the 2016 revised IRR of RA No. 9184.

18. Domestic Preference

- 18.1. The Procuring Entity will grant a margin of preference for the purpose of comparison of Bids in accordance with Section 43.1.2 of the 2016 revised IRR of RA No. 9184.

19. Detailed Evaluation and Comparison of Bids

- 19.1. The Procuring BAC shall immediately conduct a detailed evaluation of all Bids rated "*passed*," using non-discretionary pass/fail criteria. The BAC shall consider the conditions in the evaluation of Bids under Section 32.2 of the 2016 revised IRR of RA No. 9184.

- 19.2. If the Project allows partial bids, bidders may submit a proposal on any of the lots or items, and evaluation will be undertaken on a per lot or item basis, as the case may be. In this case, the Bid Security as required by **ITB** Clause 15 shall be submitted for each lot or item separately.

- 19.3. The descriptions of the lots or items shall be indicated in **Section VII (Technical Specifications)**, although the ABCs of these lots or items are indicated in the **BDS** for purposes of the NFCC computation pursuant to Section 23.4.2.6 of the 2016 revised IRR of RA No. 9184. The NFCC must be sufficient for the total of the ABCs for all the lots or items participated in by the prospective Bidder.

- 19.4. The Project shall be awarded as follows:
One Project having several items that shall be awarded as one contract.

- 19.5. Except for bidders submitting a committed Line of Credit from a Universal or Commercial Bank in lieu of its NFCC computation, all Bids must include the NFCC computation pursuant to Section 23.4.1.4 of the 2016 revised IRR of RA No. 9184, which must be sufficient for the total of the ABCs for all the lots or items participated in by the prospective Bidder. For bidders submitting the committed Line of Credit, it must be at least equal to ten percent (10%) of the ABCs for all the lots or items participated in by the prospective Bidder.

20. Post-Qualification

- 20.1. Within a non-extendible period of five (5) calendar days from receipt by the Bidder of the notice from the BAC that it submitted the Lowest Calculated Bid, the Bidder shall submit its latest income and business tax returns filed and paid through the BIR Electronic Filing and Payment System (eFPS) and other appropriate licenses and permits required by law and stated in the **BDS**.

21. Signing of the Contract

- 21.1. The documents required in Section 37.2 of the 2016 revised IRR of RA No. 9184 shall form part of the Contract. Additional Contract documents are indicated in the **BDS**.

Section III. Bid Data Sheet

Bid Data Sheet

ITB Clause	
5.3	<p>For this purpose, contracts similar to the Project shall be:</p> <ul style="list-style-type: none"> a. Supply and Delivery of Military Shoes, Rubber Shoes, Boots or other types of footwear; and b. Completed within five (5) years prior to the deadline for the submission and receipt of bids.
7.1	No portion of the contract or project shall be sub-contracted.
10	<p>For foreign bidders, the equivalent document/s issued by the appropriate authority in the country of origin of the bidder concerned must be presented. If said document has no appropriate equivalent, a Certificate of Inexistence of Appropriate Foreign Equivalent may be submitted.</p> <p>The local representative of Foreign Bidders shall also submit PhilGEPS Certificate of Registration (Platinum Membership), or a Valid and Current Proof of Authority issued by the foreign bidder (in case the authorized local representative is an individual).</p> <p>In case of a Joint Venture, each JV partner shall submit the required Legal Documents.</p>
12.1	The price of the Goods shall be quoted DDP at GS Warehouse, 1LSG, Army Support Command, PA, Camp General Servillano Aquino, San Miguel, Tarlac City and GS Warehouse, 2LSG, Army Support Command, PA, Camp General Arturo Enrile, Malagutay, Zamboanga City in the applicable International Commercial Terms (INCOTERMS) for this Project. (Locally Manufactured = No INCOTERMS;
14.1	<p>The bid security shall be in the form of a Bid Securing Declaration, or any of the following forms and amounts:</p> <ul style="list-style-type: none"> a. The amount of not less than Php3,977,008.00 [two percent (2%) of the ABC], if bid security is in cash, cashier's/manager's check, bank draft/guarantee or irrevocable letter of credit; or b. The amount of not less than Php9,942,520.00 [five percent (5%) of the ABC], if bid security is in Surety Bond. <p>Note: The bid security shall be payable to the Procuring Entity, however, if it is in the form of a manager's check, it shall be payable to the Collecting Officer, Finance Center, PA.</p>

15	<p>Each Bidder shall submit one (1) original and two (2) photocopies of the first and second components of its bid with proper tabbing.</p> <p>Note:</p> <ul style="list-style-type: none"> • Failure to submit the required original copy shall be a ground for disqualification 																					
19.3	<p>The Project shall be awarded as one contract.</p> <table border="1" data-bbox="357 517 1385 667"> <thead> <tr> <th>Description</th> <th>Qty</th> <th>Unit</th> <th>U/P</th> <th>ABC</th> <th>End User</th> </tr> </thead> <tbody> <tr> <td>Army Combat Boots, Suede, Field Use</td> <td>71,018</td> <td>pairs</td> <td>2,800.00</td> <td>198,850,400.00</td> <td>G3, PA</td> </tr> </tbody> </table>	Description	Qty	Unit	U/P	ABC	End User	Army Combat Boots, Suede, Field Use	71,018	pairs	2,800.00	198,850,400.00	G3, PA									
Description	Qty	Unit	U/P	ABC	End User																	
Army Combat Boots, Suede, Field Use	71,018	pairs	2,800.00	198,850,400.00	G3, PA																	
20.2	<p>Post-Qualification Requirements:</p> <table border="1" data-bbox="357 741 1385 2031"> <thead> <tr> <th>TAB</th> <th>Additional Post Qualification Requirements</th> <th>Legal Basis</th> </tr> </thead> <tbody> <tr> <td>A</td> <td>Registration Certificate from Securities and Exchange Commission (SEC) for corporations, Department of Trade and Industry (DTI) for sole proprietorship, or Cooperative Development Authority (CDA) for cooperatives or its equivalent document</td> <td>2016 Revised IRR of RA No 9184</td> </tr> <tr> <td>B</td> <td>Current and valid Mayor’s Permit or Business Permit issued by the local government where the principal place of business of the bidder is located</td> <td>2016 Revised IRR of RA No 9184</td> </tr> <tr> <td>C</td> <td>Tax Clearance Certificate per Executive Order 398, Series of 2005</td> <td>2016 Revised IRR of RA No 9184</td> </tr> <tr> <td>D</td> <td>Latest Income and Business Tax Returns filed and paid through the BIR Electronic Filing and Payment System (eFPS). The latest income and business tax returns are those within the last six (6) months preceding the date of bid submission.</td> <td>2016 Revised IRR of RA No 9184</td> </tr> <tr> <td>E</td> <td>Latest Audited Financial Statement showing, among others, the prospective bidder’s total and current assets and liabilities stamped “received” if manually filed or “attachment of system generated Transaction Reference Number and email to the system user” if electronically filed issued by the Bureau of Internal Revenue or its duly accredited and authorized institutions, for the preceding calendar year which should not be earlier than two (2) years from the date of bid submission.</td> <td>2016 Revised IRR of RA No 9184</td> </tr> <tr> <td>F</td> <td>Prototype samples and swatch materials for testing; OR PQ Test Result (RDC, ASCOM, PA)/Notice of Post Qualification issued by PA/PITC BAC as "Post Qualified"; OR <u>Certificate of Final Acceptance by the PA-TIAC on the item being bid for;</u> OR <u>LCRB/SCRB on the item being bid for;</u> all in the last 3 years</td> <td>List of Required Prototype Samples and Swatch Materials for Testing for Army Combat Boots, Suede, Field Use</td> </tr> </tbody> </table>	TAB	Additional Post Qualification Requirements	Legal Basis	A	Registration Certificate from Securities and Exchange Commission (SEC) for corporations, Department of Trade and Industry (DTI) for sole proprietorship, or Cooperative Development Authority (CDA) for cooperatives or its equivalent document	2016 Revised IRR of RA No 9184	B	Current and valid Mayor’s Permit or Business Permit issued by the local government where the principal place of business of the bidder is located	2016 Revised IRR of RA No 9184	C	Tax Clearance Certificate per Executive Order 398, Series of 2005	2016 Revised IRR of RA No 9184	D	Latest Income and Business Tax Returns filed and paid through the BIR Electronic Filing and Payment System (eFPS). The latest income and business tax returns are those within the last six (6) months preceding the date of bid submission.	2016 Revised IRR of RA No 9184	E	Latest Audited Financial Statement showing, among others, the prospective bidder’s total and current assets and liabilities stamped “ received ” if manually filed or “ attachment of system generated Transaction Reference Number and email to the system user ” if electronically filed issued by the Bureau of Internal Revenue or its duly accredited and authorized institutions, for the preceding calendar year which should not be earlier than two (2) years from the date of bid submission.	2016 Revised IRR of RA No 9184	F	Prototype samples and swatch materials for testing; OR PQ Test Result (RDC, ASCOM, PA)/Notice of Post Qualification issued by PA/PITC BAC as "Post Qualified"; OR <u>Certificate of Final Acceptance by the PA-TIAC on the item being bid for;</u> OR <u>LCRB/SCRB on the item being bid for;</u> all in the last 3 years	List of Required Prototype Samples and Swatch Materials for Testing for Army Combat Boots, Suede, Field Use
TAB	Additional Post Qualification Requirements	Legal Basis																				
A	Registration Certificate from Securities and Exchange Commission (SEC) for corporations, Department of Trade and Industry (DTI) for sole proprietorship, or Cooperative Development Authority (CDA) for cooperatives or its equivalent document	2016 Revised IRR of RA No 9184																				
B	Current and valid Mayor’s Permit or Business Permit issued by the local government where the principal place of business of the bidder is located	2016 Revised IRR of RA No 9184																				
C	Tax Clearance Certificate per Executive Order 398, Series of 2005	2016 Revised IRR of RA No 9184																				
D	Latest Income and Business Tax Returns filed and paid through the BIR Electronic Filing and Payment System (eFPS). The latest income and business tax returns are those within the last six (6) months preceding the date of bid submission.	2016 Revised IRR of RA No 9184																				
E	Latest Audited Financial Statement showing, among others, the prospective bidder’s total and current assets and liabilities stamped “ received ” if manually filed or “ attachment of system generated Transaction Reference Number and email to the system user ” if electronically filed issued by the Bureau of Internal Revenue or its duly accredited and authorized institutions, for the preceding calendar year which should not be earlier than two (2) years from the date of bid submission.	2016 Revised IRR of RA No 9184																				
F	Prototype samples and swatch materials for testing; OR PQ Test Result (RDC, ASCOM, PA)/Notice of Post Qualification issued by PA/PITC BAC as "Post Qualified"; OR <u>Certificate of Final Acceptance by the PA-TIAC on the item being bid for;</u> OR <u>LCRB/SCRB on the item being bid for;</u> all in the last 3 years	List of Required Prototype Samples and Swatch Materials for Testing for Army Combat Boots, Suede, Field Use																				

		<u>reckoned from the date of submission and opening of bid envelopes.</u>	under QM SPEC NR IC- 21ACBSFU dtd 05 Jul 2019
	G	Certificate from AFPPS that the bidder is not Blacklisted and has no overdue delivery if not submitted during bid opening	2016 Revised IRR of RA No 9184
	H	Certificate of Notarial Commission of the lawyer who notarized the documents submitted by the bidder or certificate from the office of the executive judge/ office of the clerk of court certifying that the notary public is appointed or commissioned for a specific period.	2016 Revised IRR of RA No 9184
	I	Supporting documents for the Ongoing Government/Private Contracts and the Single Largest Completed Contract: 1. Notice of Award, AND/OR Notice to Proceed, AND/OR Purchase Orders AND/OR Contracts for all Ongoing Contracts as listed per submitted Annex 1; 2. Notice of Award, Notice to Proceed, Purchase Orders OR Contracts relative to Single Largest Completed Contract per submitted Annex 2 3. Certificate of Completion OR Technical Inspection and Acceptance Committee (TIAC) Report OR Official Receipt (duplicate or triplicate copy) OR Sales Invoice with Collection Receipt (duplicate or triplicate copy) OR End-User’s Acceptance relative to the Single Largest Completed Contract per submitted Annex 2	2016 Revised IRR of RA No 9184
	J	Company Profile (Organization, Affiliated Companies, Production Capability)	
	K	Vicinity map /location of the business	
<p>FOR FOREIGN MANUFACTURER/BIDDER:</p> <p>➤ The equivalent to the above-enumerated Class “A” documents issued by country or place of business, in English shall be submitted. If not in English, it must be accompanied by a translation in English, which shall be authenticated by the appropriate Philippine foreign service establishment, post, or the equivalent office having jurisdiction over the foreign bidder’s affairs in the Philippines. Similar to the required authentication above, for Contracting Parties to the Apostille Convention, all said documents shall be authenticated through an</p>			

apostille pursuant to GPPB Resolution No. 13-2019 dated 23 May 2019. The English translation shall govern, for purposes of interpretation of the bid; AND

Note: *For the Local representative of the foreign bidder: It must likewise submit and present **Registration Certificate** from the Securities and Exchange Commission (SEC), Department of Trade and Industry (DTI) for sole proprietorship, or CDA for cooperatives; and, its Valid and current **Mayor's/Business permit** issued by the local government where the principal place of business of the bidder is located.*

In case of Joint Venture (both local and foreign manufacturers), both partners must present/submit the above documents.

Section IV. General Conditions of Contract

1. Scope of Contract

This Contract shall include all such items, although not specifically mentioned, that can be reasonably inferred as being required for its completion as if such items were expressly mentioned herein. All the provisions of RA No. 9184 and its 2016 revised IRR, including the Generic Procurement Manual, and associated issuances, constitute the primary source for the terms and conditions of the Contract, and thus, applicable in contract implementation. Herein clauses shall serve as the secondary source for the terms and conditions of the Contract.

This is without prejudice to Sections 74.1 and 74.2 of the 2016 revised IRR of RA No. 9184 allowing the GPPB to amend the IRR, which shall be applied to all procurement activities, the advertisement, posting, or invitation of which were issued after the effectivity of the said amendment.

Additional requirements for the completion of this Contract shall be provided in the **Special Conditions of Contract (SCC)**.

2. Advance Payment and Terms of Payment

2.1. Advance payment of the contract amount is provided under Annex “D” of the revised 2016 IRR of RA No. 9184.

2.2. The Procuring Entity is allowed to determine the terms of payment on the partial or staggered delivery of the Goods procured, provided such partial payment shall correspond to the value of the goods delivered and accepted in accordance with prevailing accounting and auditing rules and regulations. The terms of payment are indicated in the **SCC**.

3. Performance Security

Within ten (10) calendar days from receipt of the Notice of Award by the Bidder from the Procuring Entity but in no case later than prior to the signing of the Contract by both parties, the successful Bidder shall furnish the performance security in any of the forms prescribed in Section 39 of the 2016 revised IRR of RA No. 9184.

4. Inspection and Tests

The Procuring Entity or its representative shall have the right to inspect and/or to test the Goods to confirm their conformity to the specifications at no extra cost to the Procuring Entity in accordance with the Generic Procurement Manual. In addition to tests in the **SCC, Section IV (Technical Specifications)** shall specify what inspections and/or tests the Procuring Entity requires, and where they are to be conducted. The Procuring Entity shall notify the Supplier in writing, in a timely manner, of the identity of any representatives retained for these purposes.

All reasonable facilities and assistance for the inspection and testing of Goods, including access to drawings and production data, shall be provided by the Supplier to the authorized inspectors at no charge to the Procuring Entity.

5. Warranty

- 5.1 In order to assure that manufacturing defects shall be corrected by the Supplier, a warranty shall be required from the Supplier as provided under Section 62.1 of the 2016 revised IRR of RA No. 9184.
- 5.2 The Procuring Entity shall promptly notify the Supplier in writing of any claims arising under this warranty. Upon receipt of such notice, the Supplier shall, repair or replace the defective Goods or parts thereof without cost to the Procuring Entity, pursuant to the Generic Procurement Manual.

6. Liability of the Supplier

The Supplier's liability under this Contract shall be as provided by the laws of the Republic of the Philippines.

If the Supplier is a joint venture, all partners to the joint venture shall be jointly and severally liable to the Procuring Entity.

Section V. Special Conditions of Contract

Special Conditions of Contract

GCC Clause	
1	<p>Delivery and Documents –</p> <p>For purposes of the Contract, “EXW,” “FOB,” “FCA,” “CIF,” “CIP,” “DDP” and other trade terms used to describe the obligations of the parties shall have the meanings assigned to them by the current edition of INCOTERMS published by the International Chamber of Commerce, Paris. The Delivery terms of this Contract shall be as follows:</p> <p><i>For Goods supplied from abroad:</i> “The delivery terms applicable to the Contract is DDP delivered at GS Warehouse, 1LSG, Army Support Command, PA, Camp General Servillano Aquino, San Miguel, Tarlac City and GS Warehouse, 2LSG, ASCOM, PA, Camp General Arturo Enrile, Malagutay, Zamboanga City in accordance with INCOTERMS.”</p> <p><i>For Goods supplied from within the Philippines:</i> “The delivery terms applicable to this Contract is DDP delivered at GS Warehouse, 1LSG, Army Support Command, PA, Camp General Servillano Aquino, San Miguel, Tarlac City and GS Warehouse, 2LSG, ASCOM, PA, Camp General Arturo Enrile, Malagutay, Zamboanga City. Risk and title will pass from the Supplier to the Procuring Entity upon receipt and final acceptance of the Goods at their final destination.”</p> <p>Delivery of the Goods shall be made by the Supplier in accordance with the terms specified in Section VI (Schedule of Requirements).</p> <p>For purposes of this Clause the Procuring Entity’s Representative at the Project Site is: PA TIAC, APAO, OG10.</p> <p>Incidental Services –(if applicable)</p> <p>The Supplier is required to provide all of the following services, including additional services, if any, specified in Section VI. Schedule of Requirements:</p> <ol style="list-style-type: none"> a. performance or supervision of on-site assembly and/or start-up of the supplied Goods; b. furnishing of tools required for assembly and/or maintenance of the supplied Goods; c. furnishing of a detailed operations and maintenance manual for each appropriate unit of the supplied Goods; d. performance or supervision or maintenance and/or repair of the supplied Goods, for a period of time agreed by the parties, provided that this service shall not relieve the Supplier of any warranty obligations under this Contract; and

	<p>e. training of the Procuring Entity’s personnel, at the Supplier’s plant and/or on-site, in assembly, start-up, operation, maintenance, and/or repair of the supplied Goods.</p> <p>The Contract price for the Goods shall include the prices charged by the Supplier for incidental services and shall not exceed the prevailing rates charged to other parties by the Supplier for similar services.</p>
	<p>Packaging –(if applicable)</p> <p>The Supplier shall provide such packaging of the Goods as is required to prevent their damage or deterioration during transit to their final destination, as indicated in this Contract. The packaging shall be sufficient to withstand, without limitation, rough handling during transit and exposure to extreme temperatures, salt and precipitation during transit, and open storage. Packaging case size and weights shall take into consideration, where appropriate, the remoteness of the Goods’ final destination and the absence of heavy handling facilities at all points in transit.</p> <p>The packaging, marking, and documentation within and outside the packages shall comply strictly with such special requirements as shall be expressly provided for in the Contract, including additional requirements, if any, specified below, and in any subsequent instructions ordered by the Procuring Entity.</p> <p>The outer packaging must be clearly marked as specified in Section 5. Packaging and Packing of the Technical Specification for this Project.</p>
	<p>A packaging list identifying the contents and quantities of the package is to be placed on an accessible point of the outer packaging if practical. If not practical the packaging list is to be placed inside the outer packaging but outside the secondary packaging.</p> <p>Transportation –</p> <p>Where the Supplier is required under Contract to deliver the Goods CIF, CIP, or DDP, transport of the Goods to the port of destination or such other named place of destination in the Philippines, as shall be specified in this Contract, shall be arranged and paid for by the Supplier, and the cost thereof shall be included in the Contract Price.</p> <p>Where the Supplier is required under this Contract to transport the Goods to a specified place of destination within the Philippines, defined as the Project Site, transport to such place of destination in the Philippines, including insurance and storage, as shall be specified in this Contract, shall be arranged by the Supplier, and related costs shall be included in the contract price.</p>

	<p>Where the Supplier is required under Contract to deliver the Goods CIF, CIP or DDP, Goods are to be transported on carriers of Philippine registry. In the event that no carrier of Philippine registry is available, Goods may be shipped by a carrier which is not of Philippine registry provided that the Supplier obtains and presents to the Procuring Entity certification to this effect from the nearest Philippine consulate to the port of dispatch. In the event that carriers of Philippine registry are available but their schedule delays the Supplier in its performance of this Contract the period from when the Goods were first ready for shipment and the actual date of shipment, the period of delay will be considered force majeure.</p> <p>The Procuring Entity accepts no liability for the damage of Goods during transit other than those prescribed by INCOTERMS for DDP deliveries. In the case of Goods supplied from within the Philippines or supplied by domestic Suppliers, risk and title will not be deemed to have passed to the Procuring Entity until their receipt and final acceptance at the final destination.</p> <p>Intellectual Property Rights –</p> <p>The Supplier shall indemnify the Procuring Entity against all third-party claims of infringement of patent, trademark, or industrial design rights arising from use of the Goods or any part thereof.</p>
2.2	<p>Payment shall be made by Check for local Supplier, or through irrevocable Letter of Credit (LC) in case of foreign supplier/manufacturer.</p> <p>In case payment shall be made by LC, the Procuring Entity shall open the irrevocable LC in favor of the Supplier in accordance with the terms provided below in an Authorized Government Depository Bank after the approval of the Contract by the HOPE and cash transfer from the PA to the Authorized Government Depository Bank, to wit:</p> <ol style="list-style-type: none"> a. Mode of Transmission: Full cable telex/S.W.I.F.T; b. Advising and/or Confirmation: LC may be advised and/or confirmed by any bank to be identified by the Supplier, at the latter's sole expense; c. Payee Bank: The LC draft (if any) shall be drawn on the confirming bank; d. Beneficiary: [Insert name and address of Supplier with Point of Contact]; e. Currency and Amount of LC: LC shall be in Philippine Peso, in an amount equivalent to the Total Contract Price. The 95% of the amount of LC shall be released upon completion of all the required documents enumerated in SCC Clause 2.2 (f) of the Bidding Documents and the 5% shall be released upon expiration of the

	<p>warranty period provided in SCC Clause 5.1 in the Bidding Documents;</p> <p>f. Expiration Date: One Hundred Twenty (120) calendar days from issue date of the L/C</p> <p>g. The terms of payment shall be as follows: “One Time Payment” be made to the supplier at the time of final acceptance of the goods by the Procuring Entity in accordance with Section VI. Schedule of Requirements, and the submission or presentation of the following documents:</p> <ul style="list-style-type: none"> i. Supplier’s invoice showing Goods’ description, quantity, unit price, and total amount; ii. Negotiable, clean shipped on-board Bill of Lading marked “Freight Pre-Paid” and/or “Non-Negotiable Bill of Lading” or “Airway Bill”; iii. Original Supplier’s factory inspection report or certificate of pre-delivery test and inspection report by PA TIAC (as applicable); iv. Manufacturer’s and/or Supplier’s warranty certificate; v. Certificate of Origin (for imported GOODS); vi. Delivery Receipt detailing number and description of items received signed by the Procuring Entity’s representative at the Delivery Site; vii. Certificate of Acceptance by the PA Technical Inspection and Acceptance Committee (PA TIAC).
<p>3</p>	<p>If the Performance Security is in the form of a Surety Bond, it must be in the name of the Philippine Army/AFP, and its validity must be until the issuance by the Procuring Entity of the Certificate of Final Acceptance. The Surety Bond must be duly notarized and signed by the Supplier's authorized representative indicating therein his/her full name.</p>
<p>4</p>	<p>The inspections and tests that will be conducted are:</p> <p>a. Post-Qualification involving documents validation, testing and/or manufacturer’s plant visit and inspection shall be conducted by the Procuring Entity or its designated representatives (PQ Team) in order to determine the compliance to the requirements of the end-user as required in the bidding documents. Expenses incurred related hereto particularly travel and board and lodging expenses shall be borne by the Procuring Entity.</p> <p>Considering the travel restrictions brought by COVID-19 outbreak, the alternative PQI may be conducted through “table post qualification” and/or by VTC or other electronic means; and the adoption of previous PQ Reports with independent referencing within the six (6) months validity period.</p> <p>Conduct of Post Qualification abroad is subject to the issued guidelines regarding Foreign Travel of Public Official/Officers during State</p>

of Calamity or Implementation of Community Quarantine or Similar Restrictions. Considering restrictions for foreign travel during the quarantine period, the Procuring Entity or PQ Team may conduct “table post qualification” within the office, or utilize the Office of the Philippine Defense and Armed Forces Attaché (OPhilDAFA) of the country where the foreign bidder/proponent is based to conduct post qualification.

Submitted prototype/finished samples and swatches duly tested and evaluated as compliant/passed shall be the property and proper disposition of the Procuring Entity while those that were tested and evaluated as non-compliant or Post Disqualified can be retrieved by the Bidder, through an official letter request addressed to PABAC1 (Attn: Chairman, TWG), within three (3) months upon receipt of notice from PABAC1 that such Bidder was Post-Disqualified on said project, otherwise, subject prototype/finished samples and swatches shall be the property and proper disposition of the Procuring Entity.

All cost related to the testing, including the samples for random testing, shall be for the account of the bidder/supplier.

b. Pre-Production/ In-Process Production Inspection:

- 1) Pre-Production Inspection shall be conducted any time after receipt of NTP at the Manufacturer’s facility to ensure the quality of the fabric in accordance with the approved Post Qualification Sample submitted.
- 2) There will be a maximum of three (3) members of the Inspection Team.
- 3) During In-Process Inspection, the inspection team will conduct the physical inspection at the Manufacturer’s facility.
- 4) Supplier shall ensure that the raw materials (basic material) to be used in the production of the items are available for inspection.
- 5) All costs relative to the Pre-Production/In-Process Inspection including travel, board and lodging, and related expenses shall be for the account of the supplier.

Type of Inspection	Frequency	Purpose
Pre-Production	Every arrival of the raw materials per submitted Production Plan by the Supplier. The Supplier will notify Philippine Army for inspection within seven (7) calendar days before arrival of the raw materials.	Visual inspection of the arrival of the raw materials at the Manufacturer’s facility to ensure the quality of the materials in accordance with the approved Post Qualification Sample submitted.
In-Process	Per submitted Production Plan	The Inspection team will conduct the physical

			inspection at the Manufacturer's facility.
	<p>c. All Items/Goods shall be subjected to pre-shipment inspection (PSI) and test by the PA-TIAC. The PSI shall be conducted prior to the expiry of the required delivery period. Appropriate penalties for the delay shall be imposed, as applicable.</p> <p>Notes:</p> <ol style="list-style-type: none"> 1) Pre-shipment inspection of the items to be conducted by Philippine Army Inspection Team. 2) Supplier/Contractor shall notify the Procuring Entity once the items for delivery/shipment is ready for inspection by the PA-TIAC. 3) All incidental and related expenses relative to inspection particularly travel, board and lodging expenses shall be for the account of the supplier. The samples shall be over and above the quantity to be delivered. 4) The PSI shall be conducted in accordance with the prescribed PA Test and Acceptance Procedures. 5) All cost related to the testing, including the samples for random testing, shall be for the account of the bidder/supplier. 6) Item/s subject for destructive testing shall be included during delivery, but shall not be counted as part of the quantity being delivered. <p>d. Final Inspection and Acceptance at the Delivery Site.</p> <ol style="list-style-type: none"> i. Completeness and appropriateness of the delivered goods shall be conducted by the Procuring Entity's representative (PATIAC) at the delivery site. Expenses incurred related hereto particularly travel and board and lodging expenses shall be borne by the Procuring Entity. <ol style="list-style-type: none"> 1) Certificate of Final Acceptance by the TIAC 2) Inspection and Acceptance Report by GS, PAO, PA or its FPAO in the delivery site. ii. Non-Acceptance of Items - In case items are rejected, Philippine Army Technical Inspection and Acceptance Committee (PATIAC) shall issue Certificate of Non-Acceptance on the cause of non-compliance of the item. A corresponding Notice of Non-Acceptance shall then be issued by Philippine Army Procurement Center (PAPC) to the supplier further advising that the period for replacement of defective item is within thirty (30) calendar days from receipt thereof. <p>Once the allowable period of replacement exceeds, the contract shall be terminated. Supplier shall be subjected to blacklisting due to termination for default.</p>		
5.1	The warranty shall be covered by, either retention money in an amount equivalent to five percent (5%) of every progress payment, or a special bank guarantee equivalent to five percent (5%) of the Contract Price in favor of the		

	<p>Armed Forces of the Philippines. The Obligation for the warranty shall only be released after the lapse of the warranty period.</p> <p>The warranty period shall be six (6) months after acceptance by the Procuring Entity of the delivered Goods.</p> <p>The goods to be delivered must have been manufactured not more than six (6) months from the date of delivery.</p>
--	---

Section VI. Schedule of Requirements

The delivery schedule expressed as weeks/months stipulates hereafter a delivery date which is the date of delivery to the project site.

Description	Quantity	Delivery Period	Delivery Place
Army Combat Boots, Suede, Field Use	28,478 pairs	Full Delivery within One Hundred Sixty (160) Calendar Days upon Receipt of NTP	GS Warehouse, 1LSG, Army Support Command, PA, Camp General Servillano Aquino, San Miguel, Tarlac City
	42,540 pairs		GS Warehouse, 2LSG, ASCOM, PA, Camp General Arturo Enrile, Malagutay, Zamboanga City

Section VII. Technical Specifications

By 2028, a world-class Army that is a source of national pride.

HEADQUARTERS
PHILIPPINE ARMY
OFFICE OF THE ARMY QUARTERMASTER
Fort Andres Bonifacio, Metro Manila

PA SPECIFICATION

QM SPEC NR IC-21ACBSFU

JUL 05 2019

Interim

ARMY COMBAT BOOTS, SUEDE, FIELD USE

1. GENERAL

1.1. Scope – This document covers a flesh-out/suede, Full-grain Upper Cowhide leather type of combat boots, Olive Drab in color with nylon canvas that has a direct molded sole with a puncture resistant insole.

1.2. Grade – The finished boots shall be of the grade and quality of product prescribed by this specification.

1.3. Size – The sizes of the boots shall be as specified in TABLE I, but the ordering of the tariff sizes shall be determined by the contract.

TABLE I. SIZES

SIZE	Height (cm)	Insole Length (mm)	Vamp Width (mm)			
			Regular (R)		Wide (W)	
			Min	Max	Min	Max
5	24.0 ± 1.0	255 ± 3	164.00	168.00	171.00	175.00
5 ½	24.0 ± 1.0	258 ± 3	168.00	171.00	175.00	178.00
6	24.0 ± 1.0	260 ± 3	171.00	175.00	178.00	182.00
6 ½	24.5 ± 1.0	264 ± 3	175.00	178.00	182.00	185.00
7	24.5 ± 1.0	270 ± 3	178.00	182.00	185.00	189.00
7 ½	24.5 ± 1.0	274 ± 3	182.00	185.00	189.00	192.00
8	25.0 ± 1.0	277 ± 3	185.00	189.00	192.00	196.00
8 ½	25.0 ± 1.0	282 ± 3	189.00	192.00	196.00	199.00
9	25.0 ± 1.0	287 ± 3	192.00	196.00	199.00	203.00
9 ½	25.5 ± 1.0	292 ± 3	196.00	199.00	203.00	206.00
10	25.5 ± 1.0	296 ± 3	199.00	203.00	206.00	210.00
10 ½	25.5 ± 1.0	299 ± 3	203.00	206.00	210.00	213.00
11	26.0 ± 1.0	302 ± 3	206.00	210.00	213.00	217.00
11 ½	26.0 ± 1.0	305 ± 3	210.00	213.00	217.00	220.00
12	26.0 ± 1.0	308 ± 3	213.00	217.00	220.00	224.00
12 ½	26.0 ± 1.0	311 ± 3	217.00	220.00	224.00	227.00



Page 1 of 15
Honor. Patriotism. Duty

By 2028, a world-class Army that is a source of national pride.

PA SPECIFICATION

QM SPEC NR IC-21ACBSFU

JUL 05 2019

Interim

2. REQUIREMENTS

2.1. First Article – Two (2) samples of the finished combat boots submitted to the Office of Army Quartermaster shall be subjected to first article inspection in accordance with para 3.1.

2.2. Materials

2.2.1. Leather

2.2.1.1. Vamp, Outer Counter Pocket, Inside Counter Lining and Outer Eyelet Stay & Inner Eyelet Stay Lining Leather – The leather shall be Flesh-out / suede, full-grain upper cowhide leather, Olive Drab in color and shall conform with the following requirements:

Thickness, mm (Cut Parts)	
Vamp	2.0 (minimum)
Outer Counter Pocket	1.8 (minimum)
Inside Counter Lining	1.0 (minimum)
Outer Eyelet Stay	1.6 (minimum)
Inner Eyelet Stay Lining	1.4 (minimum)
Color Quality (Spectrophotometer Method) A & B	2.0 (maximum)
Water Absorption, % 30 minutes	20% (maximum)

2.2.2. Counter Material – The counter material shall be cut from impregnated material and shall conform with the following requirements:

Thickness, mm	1.8 (minimum)
Weight, g/m ²	2,200 (maximum)
Tensile Strength, kg/2.54 cm (Strip Method)	95 (minimum)
Breaking Strength, Kg (Grab Method)	
Direction A	260 (minimum)
Direction B	200 (minimum)

2.2.3. Box Toes – The box toes shall be cut from impregnated material and shall conform with the following requirements:

Thickness, mm	1.8 (minimum)
Weight, g/m ²	1,800 (maximum)
Tensile Strength, kg/2.54 cm (Strip Method)	70 (minimum)
Breaking Strength, Kg (Grab Method)	
Direction A	180 (minimum)
Direction B	165 (minimum)

By 2028, a world-class Army that is a source of national pride.

PA SPECIFICATION

QM SPEC NR IC-21ACBSFU

JUL 0 5 2019
Interim

2.2.4. Fabrics

2.2.4.1. Quarter and Gusset Material - The quarters and gussets shall be nylon, olive drab in color and shall conform with the following requirements:

Thickness, mm	0.40 - 0.80
Weight, g/m ²	400 (maximum)
Breaking Strength, Kg (Grab Method)	
Warp	250 (minimum)
Filling	210 (minimum)
Thread Count/ 2.54 cm	
Warp	30 (minimum)
Filling	24 (minimum)
Yarn Size, Denier	
Warp	1,000 (minimum)
Filling	1,000 (minimum)
Type of Weave	Plain
Color Quality (Spectrophotometer Method)	2.0 (maximum)

2.2.3.2 Vamp Lining - The vamp lining shall be cut from cotton or polyester canvas and shall conform with the following:

Thickness, mm	0.40 - 1.10
Weight, g/m ²	600 (maximum)
Breaking Strength, Kg (Grab Method)	
Warp	115 (minimum)
Filling	105 (minimum)
Thread Count/ 2.54 cm	
Warp	35 (minimum)
Filling	30 (minimum)
Yarn Size, Denier	
Warp	600 (minimum)
Filling	600 (minimum)
Type of Weave	Twill
Color	Black



By 2028, a world-class Army that is a source of national pride.

PA SPECIFICATION

QM SPEC NR IC-21ACBSFU

JUL 05 2019

Interim

2.2.3.3 Eyelet Stay Reinforcement – The eyelet stay reinforcement shall be cut from non-woven polyester/nylon fiber material.

Thickness, mm	0.40 - 0.8
Weight, g/m ²	420 (maximum)
Breaking Strength, Kg (Grab Method)	
Direction A	140 (minimum)
Direction B	130 (minimum)

2.2.3.4 Binding Tape - The binding tape for the top edge of the gusset shall be nylon, dark green in color and shall conform to the following requirements:

Thickness, mm	0.30 - 0.80
Type of Weave	Plain Double
Weight, g/linear meter	8.0 (maximum)
Breaking Strength, Kg (Grab Method)	90 (minimum)
Width, cm	1.60 – 2.00
Color Quality (Spectrophotometer Method)	2.0 (maximum)

2.2.3.5 Quarter Top Facing, Backstay and Ankle Reinforcement Tapes - The quarter top facing, backstay and ankle reinforcement tapes shall be nylon webbing. The webbing shall be Olive Drab in color and shall conform with following requirements:

	Quarter Top Facing and Backstay Tape	Ankle Reinforcement Tape
Width, cm	2.30 – 2.80	4.80 – 5.20
Thickness, mm	1.10 - 1.60	1.10 - 1.60
Breaking Strength, Kg	325 (minimum)	650 (minimum)
Thread Count/ 2.54 cm		
Warp	115 (minimum)	115 (minimum)
Filling	40 (minimum)	40 (minimum)
Yarn Size, Denier		
Warp	800 (minimum)	800 (minimum)
Filling	490 (minimum)	490 (minimum)
Type of Weave	Plain Double	Plain Double
Color Quality (Spectrophotometer Method)	2.0 (maximum)	2.0 (maximum)

2.2.3.6 Footbed Cushion/Sock Lining – The footbed cushion/removable sock lining shall be made of pre-molded high-grade cushion material with Olive Drab knitted fabric with a total thickness of 3.0 - 8.0 mm from toe to heel portion. The cushion material should be black in color with an open-cell structure design, as illustrated in Figure 3A and 3B. It should have the manufacturer's name or logo imprinted on the center heel portion. It shall fit properly to the applicable size of the boot.



Page 4 of 15

Honor. Patriotism. Duty.

By 2028, a world-class Army that is a source of national pride.

PA SPECIFICATION

QM SPEC NR IC-21ACBSFU

JUL 05 2019

Interim

2.2.3.7 Insole Construction Assembly - The insole shall be of 2-piece construction. Top layer shall be made from a multiple layered tightly non-woven polyester/nylon fabric formed from high tensile strength and puncture resistant material. The bottom layer shall be made from Split leather insole. The two materials shall then be glued and stitched together to form the insole assembly. It shall conform with the following requirements:

Top Layer - Multiple Layered non-woven polyester/nylon fabric	
Thickness, mm	3.0 - 5.0
Weight, g/m ²	4,000 (maximum)
Puncture Resistance (ISO 20344 or ASTM F2412 Test Method)	Shall withstand a resistive force of 122.5 kgf minimum without penetration
Color	Natural or White
Bottom Layer - Split Leather Insole	
Thickness, mm	1.30 - 2.00

2.2.4 Metals

2.2.4.1 Eyelet - The eyelet shall be made of brass or aluminum, enamel coated, olive drab in color. Should have a roll setting barrel and shall conform with the following finished requirements when tested:

Outside diameter	1.19 cm - 1.25 cm
Inside diameter	0.50 cm - 0.65 cm

2.2.4.2 Speed Lace Loops - The speed lace loops shall be made of brass, enamel coated and olive drab in color.

2.2.4.3 Drainage Eyelet with Washers - The drainage eyelet shall be brass, mesh eyelet olive drab in color, with a diameter head of 11.0 mm ± 1.10 mm.

2.2.5 Outsole and Heel Rubber - The bottom assembly for both rubber outsole and heel shall have the following characteristics:

2.2.5.1 Color - The color shall be Olive Drab, non-marking, producing only a slight erasable mark on white paper.

2.2.5.2 Abrasion Resistance. - The loss in weight due to abrasion resistance shall be not more than 90 mg.

By 2028, a world-class Army that is a source of national pride.

PA SPECIFICATION

QM SPEC NR IC-21ACBSFU

JUL 0 5 2019

Interim

2.2.5.3 Flex Resistance - The outsole, heel rubber and leather shall not show sign of cracks or splits and shall have no separation between the upper after a minimum of 150 hours of continuous flexing.

2.2.5.4 Bond Strength - The bond strength shall be not less than 70.0 kgs.

2.2.5.5 Hardness - The durometer hardness shall be 65 ± 10 Shore A.

2.2.5.6 Bottom Design - The bottom design shall be of the Panama style with Honeycomb traction.

2.2.5.7 Markings - The outsole shall be marked by sizes and contractors identification as shown in Figure 3C.

2.2.6 Thread, Upper Fitting - The thread for all fitting operations shall be nylon or polyester, 3-ply (minimum), olive drab with a minimum breaking strength of 5.0 Kgs.

2.2.7 Thread, Insole Stitching - The thread for stitching the insole assembly shall be natural/white in color, made of nylon or polyester, 4 ply (maximum), with a minimum breaking strength of 20.0 Kgs.

2.2.8 Lace Material - The laces should be round type braided nylon/polyester, olive drab in color, shall be reinforced with plastic tips $1.8 \text{ cm} \pm 0.3 \text{ cm}$. The minimum length of the lace shall be 160.0 cm with a breaking strength of not less than 75.0 kg.

2.2.9 Miscellaneous materials.

2.2.9.1 Fiber Shank - The shank shall be made of high-grade compressed hard fiber, with thickness of 1.90 - 2.50 mm, width of 1.40 - 2.00 cm. The length of the shank shall conform to the following requirements.

Boot Size	5 to 6.5	7 to 8.5	9 to 10.5	11 to 12½	Tolerance
Shank length in cm	10.0	10.5	11.0	11.5	± 1.5

2.2.9.2 Heel Fillers - The heel fillers shall be made of wood or other suitable material that does not affect vulcanization or proper molding of the heel. The fillers shall be heel-shaped with straight edges.



Page 6 of 15

Honor. Patriotism. Duty

By 2028, a world-class Army that is a source of national pride.

PA SPECIFICATION

QM SPEC NR IC-21ACBSFU

JUL 0 5 2019

Interim

2.2.9.3 Instruction Tag - Instruction tag, to be tied to the finished boots, shall be printed using the data provided in Illustration 1. The tag shall be printed on tag stock that is 12 cm by 16 cm and folded in the middle to form four printed pages in book form that are 12 cm by 8 cm. A punch hole shall be made in the top near the folded edge for insertion of the lace.

2.3 Construction

2.3.1 The combat boots shall be constructed using the latest technology of the manufacturer and shall conform to the design as shown in the FIGURES 1, 2, and 3.

2.3.2 Contractor's Label. - The gusset of each boot should have a contractor's label (3 ± 0.5 cm x 6 ± 0.5 cm) sewed to the inside portion and from the top center of the gussets with the correct size and width, the contractor's identification symbol, the month and year (expressed numerically) of the manufacture date, and words, "ARMY COMBAT BOOTS, SUEDE, FIELD USE". Lot number marking shall also be included. The figures and letters shall be readable and proportion. The label shall be expressed as shown in the following example; alternate formats may be used provided all the data elements are included and requirements are met:



2.3.3 Upper Stitching - The upper stitching shall be eight (8) to ten (10) stitches for every 2.54 cm.

2.3.4 The eyeletstay shall have a V-cut with a depth of 1.5 ± 0.3 cm located at the center of the eyelet and the speed lace loop as shown in Figure 3D.

2.3.5 Speed Lacing and Eyeleting – On each quarter, there shall be five (5) speed lace loops on the upper portion and three (3) eyelets at the bottom spaced evenly from blucher nose to top of quarter. There shall be two (2) drainage eyelet located just above the insole on the finished boot as illustrated in FIGURE 1.

Page 7 of 15

Honor. Patriotism. Duty.



By 2028, a world-class Army that is a source of national pride.

PA SPECIFICATION

QM SPEC NR IC-21ACBSFU

JUL 05 2019

Interim

2.3.6 Instruction Tag – One instruction tag containing the information as shown in Illustration 1 shall be attached to each pair of boots.

2.3.7 Height – The height of the finished boot, shall be measured upward on outside from Bottom heel to top collar of boot. (see FIGURE 5)

2.3.8 Vamp Width – The vamp width of the finished boot shall be measured from sole to sole passing over the vamp at the front edge of the two eyelet stays. (see FIGURE 4)

2.4 Workmanship

2.4.1 Design – The design of the finished boots shall be essentially the same with the official sample of the Philippine Army. The boots shall be for a full lace closure boot with puncture resistant insole with a removable cushioned sock lining. The upper must be made of full grain fleshout upper leather stitched and assembled with nylon canvass quarter and gusset stitched with backstay, top and ankle reinforcement straps. The rubber outersole design shall be of the panama style with honeycomb traction.

2.4.2 Finish – The finished combat boots shall be free from defects, such as missing components, incorrect stitching patterns, unspecified materials, unmatched pairs, crooked box toe, unspecified color, wrong type or placement of hardware components, protruding points in insole, lack of puncture resistant insole, or missing instruction label. The boots shall also be free from stains or foreign matter affecting appearance.

3 VERIFICATION

3.1 First Article Inspection – The contractor shall furnish two (2) samples of the Boots for first article inspection and approval as against the bid sample. The sample shall be subjected to tests and examination to verify if the requirements in para 2.2 through 2.3 are satisfied, with referenced to the attached test parameters and classification of defects of this document.

3.2 Sampling

3.2.1 Samples of materials, components and other items entering into the manufacture of the combat boots may be taken at random from time to time by PA inspectors for the purpose of examination and test to determine compliance with the requirements of this specification.

3.2.2 Pre-production Sample – Before actual production starts, unless otherwise specified, two (2) pairs finished samples of the combat boots shall be submitted to the RDC, ASCOM, PA for verification whether the quality of the materials used conformed with the characteristics/requirements of the specification and (1) pair finished combat boots to the Office of Army Quartermaster for approval as to design, construction, workmanship, style and finish.



Page 8 of 15

Honor. Patriotism. Duty

By 2028, a world-class Army that is a source of national pride.

PA SPECIFICATION

QM SPEC NR IC-21ACBSFU

JUL 0 5 2019

Interim

4. QUALITY ASSURANCE PROVISIONS

Responsibility of Inspection – Unless otherwise specified in the contract or purchase order, the contractor is responsible for the performance of all inspection requirements as specified herein. Except as otherwise specified in the contract or purchase order, the contractor may use his own or any other facilities suitable for the performance of inspection requirements specified herein, unless disapproved by the Government. The Government reserves the right to perform any of the inspections set forth in this document where such inspections are deemed necessary to assure supplies and services conform to prescribed requirements.

5. PACKAGING AND PACKING

5.1. Packaging – Each pair of properly mated boots should then be placed on an individual shoe box with onion skin wrapped around each shoe for protection. The box should have the manufacturer’s logo printed on the top. It should be accompanied by label with the details of the shoe and its origin and other important matters.

5.2. Packing on Master Box – Twelve (12) pairs of boots in the shoe box of the same size shall be packed in a corrugated carton, in suitable size. The top cover, when closed, shall be sealed with a binding tape and finally secured with nylon straps. The box shall be labeled as follows:

ARMY COMBAT BOOTS, SUEDE, FIELD USE
(Name of Contractor)
QTY: 12 pairs
SIZE: ___

6. NOTES

6.1. Any point not covered by this text shall be supported by the attached illustrations as reference and guide of the contractor.

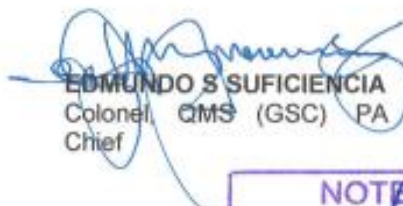
EDMUNDO S SUFICIENCIA
Colonel, QMS (GSC) PA
Chief

NOTED
CG, PA W
DATE: JUL 0 5 2019



Page 9 of 15
Honor. Patriotism. Duty

By 2028, a world-class Army that is a source of national pride.

PA SPECIFICATION

QM SPEC NR IC-21ACBSFU

JUL 05 2019

Interim

INSTRUCTION TAG

ARMY COMBAT BOOTS, SUEDE, FIELD USE

Proper Usage, Storage and Care

- Wear with socks and footbed cushion/sock lining.
- Before wearing the boots, carefully inspect the inside of the boots for any foreign objects, insects, etc. to avoid painful and disabling bites and stings or any other injuries.
- Do not leave the shoe in a place with high temperature/humidity such as in cars or non-ventilated closets/cabinets.
- When drying the shoe, place it under the shade with high ventilation and do not force-dry it by using a machine dryer or by drying it under direct sunlight.
- Store footwear in a cool and dry place
- After use, brush away surface dirt with a soft brush, loosen laces to fully open each shoe and place in a ventilated area to dry.

Cleaning guide for natural fleshout suede upper leather

- Put small portion of water with mild detergent on a white cloth, and apply it lightly on upper to remove stains.
- Use soft white cloth to wipe extra wet surface and then air dry.
- In case of mud stains, moisten the mud stain spot with clean cold water, and apply mild and soft detergent to remove the stain. After hand wash, insert white cloth or paper in shoes, dry it under shade with high ventilation (not on direct sunlight).
- Remove all dusts in fiber neatly with a hairbrush or nylon brush.
- After drying and brush it again for finish. Enjoy the smooth supple texture on face skin.

**DO NOT MACHINE WASH OR MACHINE DRY.
The shoes/footwear should
NOT BE DRIED UNDER DIRECT/EXTREME SUNLIGHT.**

Instructions for use and maintenance of Boots

Illustration 1



Page 10 of 15
Honor. Patriotism. Duty.

By 2028, a world-class Army that is a source of national pride.

PA SPECIFICATION

QM SPEC NR IC-21ACBSFU

JUL 05 2019

Interim

ARMY COMBAT BOOTS, SUEDE, FIELD USE

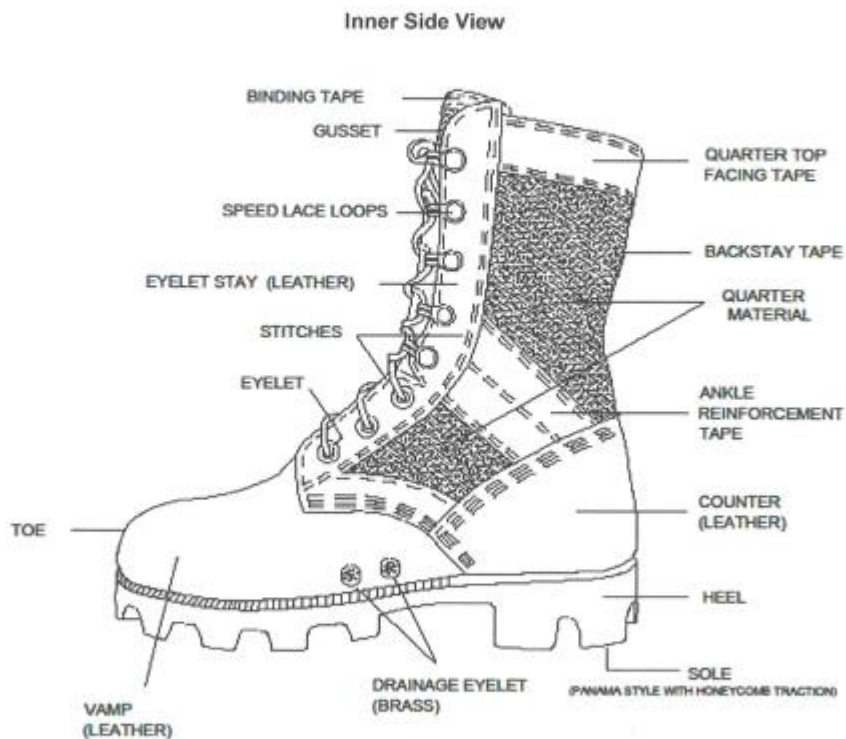

FIGURE 1



Page 11 of 15
Honor. Patriotism. Duty

By 2028, a world-class Army that is a source of national pride.

PA SPECIFICATION

QM SPEC NR IC-21ACBSFU

JUL 0 5 2019

Interim



Front View



Back View



Quarter Side View

FIGURE 2

Page 12 of 15

Honor. Patriotism. Duty



By 2028, a world-class Army that is a source of national pride.

PA SPECIFICATION

QM SPEC NR IC-21ACBSFU

JUL 05 2019

Interim

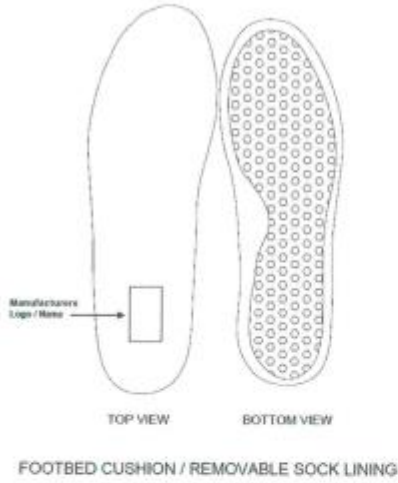

Figure 3A

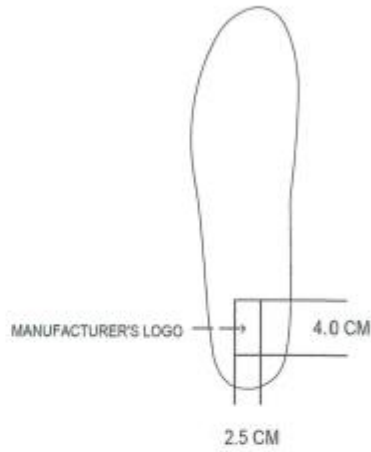

Figure 3B

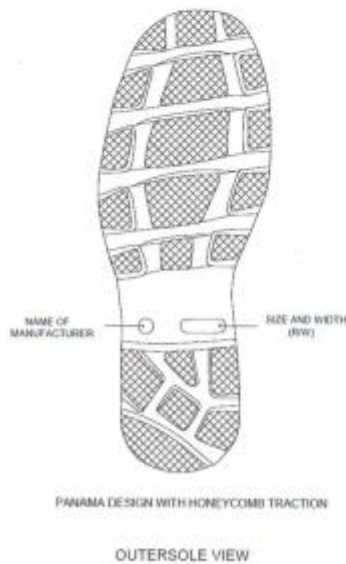
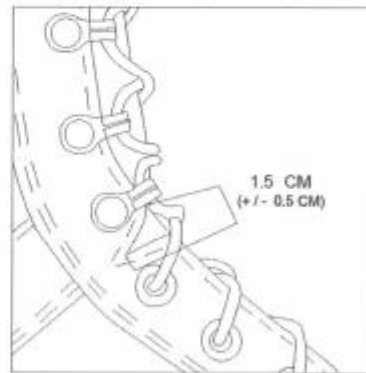

Figure 3C

FIGURE 3



V-Cut Measurement

Figure 3D



By 2028, a world-class Army that is a source of national pride.

PA SPECIFICATION

QM SPEC NR IC-21ACBSFU
JUL 0 5 2019

Interim

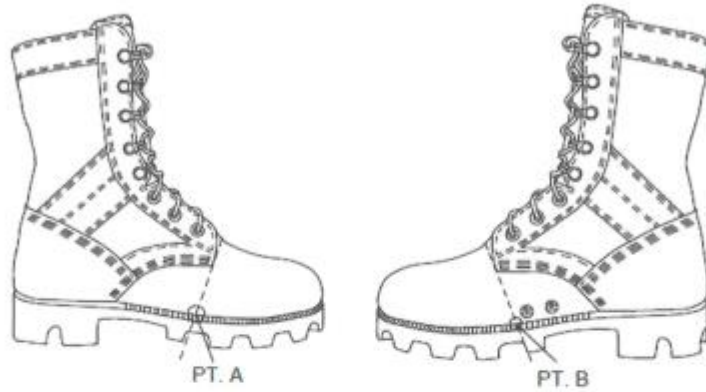

VAMP WIDTH MEASUREMENTS
PT. A TO PT. B

FIGURE 4



By 2028, a world-class Army that is a source of national pride.

PA SPECIFICATION

QM SPEC NR IC-21ACBSFU

JUL 0 5 2019

Interim



FIGURE 5



Page 15 of 15
Honor. Patriotism. Duty

By 2028, a world-class Army that is a source of national pride.

**HEADQUARTERS
PHILIPPINE ARMY
OFFICE OF THE ARMY QUARTERMASTER
Fort Andres Bonifacio, Metro Manila**

PA SPECIFICATION

QM SPEC NR IC-21ACBSFU

JUL 0 5 2019

Interim

**ARMY COMBAT BOOTS, SUEDE, FIELD USE
(Actual Pictures)**



Page 1 of 2
Honor. Patriotism. Duty

By 2028, a world-class Army that is a source of national pride.

PA SPECIFICATION

QM SPEC NR IC-21ACBSFU

JUL 05 2019

Interim



Front View



Back View



Perspective View



Page 2 of 2
Honor. Patriotism. Duty

By 2028, a world class Army that is a source of national pride.

HEADQUARTERS
PHILIPPINE ARMY
OFFICE OF THE ARMY QUARTERMASTER
Fort Andres Bonifacio, Metro Manila

TEST PARAMETERS

ARMY COMBAT BOOTS, SUEDE, FIELD USE

TEST PARAMETERS	QM SPEC NR IC-21ACBSFU dtd 05 July 2019	Classification of Defects	
		Major	Minor
Leather	Shall be flesh-out/Suede, full grain, upper cowhide leather	X	
Thickness,mm			
Vamp	2.0 (minimum)		X
Outer Counter Pocket	1.8 (minimum)		X
Inside Counter Lining	1.0 (minimum)		X
Outer Eyelets Stay	1.6 (minimum)		X
Inner Eyelets Stay Lining	1.4 (minimum)		X
Color	Olive Drab	X	
Color Quality (Spectrophotometric Method) A & B	2 (maximum)	X	
Water absorption, % (30 minutes)	20 (maximum)	X	
Counter Material	Shall be cut from impregnated material	X	
Thickness, mm	1.8 (minimum)		X
Weight, g/m ²	2,200 (maximum)		X
Tensile Strength, kg/2.54 cm (Strip Method)	95 (minimum)	X	
Breaking Strength, Kg (Grab Method)			
Direction A	260 (minimum)	X	
Direction B	200 (minimum)	X	
Box Toes	Shall be cut from impregnated material	X	
Thickness, mm	1.8 (minimum)		X
Weight, g/m ²	1,800 (maximum)		X
Tensile Strength, kg/2.54 cm (Strip Method)	70 (minimum)	X	
Breaking Strength, Kg (Grab Method)			
Direction A	180 (minimum)	X	
Direction B	165 (minimum)	X	
Quarter & Gusset Material	Nylon	X	
Color	Olive Drab	X	
Thickness, mm	0.40 - 0.80		X
Weight, g/m ²	400 (maximum)		X
Breaking Strength, Kg (Grab Method)			
Warp	250 (minimum)	X	
Filling	210 (minimum)	X	

Honor. Patriotism. Duty



Page 1 of 5

By 2028, a world class Army that is a source of national pride.

TEST PARAMETERS	QM SPEC NR IC-21ACBSFU dtd 05 July 2019	Classification of Defects	
		Major	Minor
Thread Count/ 2.54 cm			
Warp	30 (minimum)		X
Filling	24 (minimum)		X
Yarn Size, Denier			
Warp	1,000 (minimum)		X
Filling	1,000 (minimum)		X
Type of Weave	Plain		X
Color Quality (Spectrophotometer Method)	2.0 (maximum)	X	
Vamp Lining	Cut from cotton canvass or polyester canvas	X	
Thickness, mm	0.40 - 1.10		X
Weight, g/m ²	600 (maximum)		X
Breaking Strength, Kg (Grab Method)			
Warp	115 (minimum)	X	
Filling	105 (minimum)	X	
Thread Count/ 2.54 cm			
Warp	35 (minimum)		X
Filling	30 (minimum)		X
Yarn Size, Denier			
Warp	600 (minimum)		X
Filling	600 (minimum)		X
Type of Weave	Twill		X
Color	Black		X
Eyelet Stay Reinforcement	cut from non-woven polyester/nylon fiber material	X	
Thickness, mm	0.40 - 0.8		X
Weight, g/m ²	420 (maximum)		X
Breaking Strength, Kg (Grab Method)			
Direction A	140 (minimum)	X	
Direction B	130 (minimum)	X	
Binding Tape	Nylon	X	
Color	Dark Green	X	
Thickness, mm	0.30 - 0.80		X
Type of Weave	Plain Double		X
Weight, g/linear meter	8.0 (maximum)		X
Breaking Strength, Kg (Grab Method)	90 (minimum)	X	
Width, cm	1.60 - 2.00		X
Color Quality (Spectrophotometer Method)	2.0 (maximum)	X	
Quarter Top Facing and Backstay Tapes	Nylon	X	
Width, cm	2.30 - 2.80		X
Thickness, mm	1.10 - 1.60		X
Breaking Strength, kg	325 (minimum)	X	



Honor. Patriotism. Duty.

Page 2 of 5

By 2028, a world class Army that is a source of national pride.

TEST PARAMETERS	QM SPEC NR IC-21ACBSFU dtd 05 July 2019	Classification of Defects	
		Major	Minor
Thread Count/2.54 cm			
Warp	115 (minimum)		X
Filling	40 (minimum)		X
Yarn Size, Denier			
Warp	800 (minimum)		X
Filling	490 (minimum)		X
Type of Weave	Plain Double		X
Color	Dark Green	X	
Color Quality (Spectrophotometric Method)	2.0 (maximum)	X	
Ankle Reinforcement Tape	Nylon	X	
Width, cm	4.80 – 5.20		X
Thickness, mm	1.10 – 1.60		X
Breaking Strength, kg	650 (minimum)	X	
Thread Count/2.54 cm			
Warp	115 (minimum)		X
Filling	40 (minimum)		X
Yarn Size, Denier			
Warp	800 (minimum)		X
Filling	490 (minimum)		X
Type of Weave	Plain Double		X
Color	Dark Green	X	
Color Quality (Spectrophotometric Method)	2.0 (maximum)	X	
Footbed Cushion System/Sock Lining	Shall be pre-molded high-grade cushion material with Olive Drab knitted fabric	X	
Thickness (mm)	3.0 - 8.0		X
Color	Black	X	
	The cushion material should have an open-cell structure as illustrated in Figure 3A and 3B.	X	
	Should have the manufacturer's name or logo imprinted on the center heel portion		X
	Shall be properly fit to the applicable size of the boot.	X	
Insole Construction Assembly	shall be of 2-piece construction	X	
Top Layer	Multiple Layered non-woven polyester/nylon fabric	X	
Thickness, mm	3.0 - 5.0		X
Weight, g/m ²	4,000 (maximum)		X
Puncture Resistance	Shall withstand a resistive force of 122.5 kgf minimum without penetration	X	
Color	Natural or White		X
Bottom Layer	Shall be made from Split leather insole	X	
Thickness, mm	1.30 - 2.00		X
Metals			
Eyelet	Brass or Aluminum	X	
Color	Olive Drab	X	
Outside diameter	1.19 cm – 1.25 cm		X
Inside diameter	0.50 cm – 0.65 cm		X

Honor. Patriotism. Duty.



Page 3 of 5

By 2028, a world class Army that is a source of national pride.

TEST PARAMETERS	QM SPEC NR IC-21ACBSFU dtd 05 July 2019	Classification of Defects	
		Major	Minor
Speed Lace Loop	Shall be made of brass and coated enamel	X	
Color	Olive Drab	X	
Drainage eyelet with washers	Brass, mesh		X
Color	Olive Drab	X	
Diameter of Head, mm	11 mm ± 1.10 mm		X
Outsole & Heel Rubber			
Color	Olive Drab	X	
Abrasion Resistance (Loss in weight), mg	90 (maximum)	X	
Flex Resistance	Shall not show sign of cracks or splits and shall have no separation between the upper after a minimum of 150 hours continuous flexing	X	
Bond Strength, kgs	70 (minimum)	X	
Hardness, (Shore A)	Shall be 65 ± 10	X	
Bottom Design	Shall be of the Panama style with honeycomb traction.	X	
Markings	Marked by size and contractor's identifications	X	
Thread, Upper Fitting	Nylon or Polyester	X	
No. of Ply	3 (minimum)		X
Color	Olive Drab	X	
Breaking Strength, kg	5.0 (minimum)	X	
Thread, Insole Stitching	Nylon or Polyester	X	
Color	Natural/White	X	
No. of Ply	4 (maximum)		X
Breaking Strength, kg	20.0 (minimum)	X	
Lace Material	be round type braided nylon/polyester	X	
	Shall be reinforced with plastic tips 1.8 ± 0.3 cm		X
Color	Olive Drab	X	
Length, cm	160 (minimum)	X	
Breaking Strength, kg	75.0 (minimum)	X	
Fiber Shank	High grade compressed hard fiber	X	
Thickness, mm	1.90 – 2.50		X
Width, cm	1.40 – 2.00		X
Length, cm	Boot Size _____ (See para 2.2.9.1)		X
Heel Fillers	Shall be made of wood or other suitable material that does not affect vulcanization or proper molding of the heel		X
	Shall be heel-shaped with straight edges		X
Instruction Tag	To be tied to the finished boots		X
	Shall be printed using the data supplied in Illustration 1		
	tag shall be printed on tag stock that is 12 cm by 16 cm and folded in the middle to form four printed pages in book form that are 12 cm by 8 cm		
	A punch hole shall be made in the top near the folded edge for insertion of the lace.		
	To be tied to the finished boots		
Construction			
Insole Length, mm	Boot Size: ____ (See Table I)	X	

Honor. Patriotism. Duty



Page 4 of 5

By 2028, a world class Army that is a source of national pride.

TEST PARAMETERS	QM SPEC NR IC-21ACBSFU dtd 05 July 2019	Classification of Defects	
		Major	Minor
Contractor's Label	With contractor's label	X	
Dimensions, cm	3 ± 0.5 x 6 ± 0.5		X
Contents of Label	ARMY COMBAT BOOTS, SUEDE, FIELD USE		X
	Manufacturer: _____		
	Date of Manufacture: _____		
	Lot No: _____		
Upper Stitching	Size: _____		
Upper Stitching No. of Stitches/2.54 cm	8 – 10 stitches		X
Eyeletstay	Shall have a V-Cut	X	
	Shall have a depth of 1.5 ± 0.3 cm located at the center of the eyelet and the speed lace loop as shown in the Figure 3D		X
Speed Lacing and Eyeleting	On each quarter, there shall be five (5) speed lace loops on the upper portion and three (3) eyelets at the bottom spaced evenly from blucher nose to top of quarter	X	
Instruction Tag	Shall have One (1) Instruction Tag	X	
	Shall have two (2) drainage eyelet located just above the insole on the finished boot as illustrated in FIGURE 1	X	
Height, cm	Boot Size: _____ (See Table I) (see FIGURE 5)	X	
Vamp Width, mm	Boot Size: _____ (See Table I) (see FIGURE 4)	X	
Workmanship			
Design	Shall be for a full lace closure boot with puncture resistant insole with a removable cushioned sock lining	X	
Total Test Points		75	67

EDMONDO S. SUFICIENCIA
 Colonel, QMS (GSC) PA
 Chief

Honor. Patriotism. Duty



Page 5 of 5

By 2028, a world class Army that is a source of national pride.

HEADQUARTERS
PHILIPPINE ARMY
OFFICE OF THE ARMY QUARTERMASTER
Fort Andres Bonifacio, Metro Manila

ARMY COMBAT BOOTS, SUEDE, FIELD USE
QM SPEC NR IC-21ACBSFU dtd 05 July 2019

TEST CRITERIA

FOR POST-QUALIFICATION TEST:

Destructive Testing Criteria based on Logistic Letter Directive Number SC-07-04 dtd 25 October 2007 para 5f.

TOTAL MINOR TEST POINTS	NO. OF ALLOWABLE DEFECTS	
	MAJOR	MINOR
67	0	6

1. No major defect allowed.
2. Maximum allowable minor defect is nine & 9/10 percent (9.9%) of total minor test points "CONDUCTED"

FOR ACCEPTANCE TEST:

- I. Visual Inspection Criteria based on Mil Std 105E dtd 10 May 1989
 - All defects noted in 1st and 2nd sampling are cumulative.
 - In case of rejection, destructive testing will not be conducted

Classification of Defects	TABLE III-A General Inspection Level I Code Letter K Double Sampling Plan for Normal Inspection				
	Lot size 10,001 – 35,000 pcs Sample Size: 80 pcs + 80 pcs	Number of Defects			
		AQL	1 st Sampling	2 nd Sampling	Accept
MAJOR	6.5	7	11	18	19
MINOR	25	11	16	26	27

- II. Destructive Testing Criteria based on Logistic Letter Directive Number SC-07-04 dtd 25 October 2007 para 5f.

TOTAL MINOR TEST POINTS	NO. OF ALLOWABLE DEFECTS	
	MAJOR	MINOR
67	0	6

1. No major defect allowed.
2. Maximum allowable minor defect is nine & 9/10 percent (9.9%) of total minor test points "CONDUCTED"

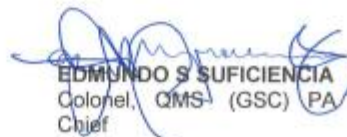
EDMUNDO S. SUFICIENCIA
Colonel, QMS (GSC) PA
Chief



By 2028, a world-class Army that is a source of national pride.

**HEADQUARTERS
PHILIPPINE ARMY
OFFICE OF THE ARMY QUARTERMASTER
Fort Andres Bonifacio, Metro Manila**

**ARMY COMBAT BOOTS, SUEDE, FIELD USE
QM SPEC NR IC-21ACBSFUdtd 05 July 2019**

LIST OF REQUIRED PROTOTYPE SAMPLES AND SWATCH MATERIALS FOR TESTING

1. FOR POST QUALIFICATION TEST

PROTOTYPE SAMPLES

sizes RDC – Three (3) pairs, any size but the Three (3) pairs must be of same
OAQM – One (1) pair

SWATCH MATERIALS (Minimum requirement)

Upper Leather	40 cm x 40 cm
Counter Material	50 cm x 50 cm
Box Toe Material	50 cm x 50 cm
Quarter and Gusset Material	1 meter full width
Vamp Lining	80 cm x 100 cm
Eyelet Stay Reinforcement	80 cm x 100 cm
Binding Tape	1.5 meters
Quarter Top Facing, Backstay	1.5 meters
Ankle Reinforcement Tapes	1.5 meters
Footbed Cushion/Sock Lining	1 pair
Insole Construction Assembly	3 pairs
Fiber shank	1 pair
Thread for Upper Fitting	10 meters
Thread for Insole Stitching	10 meters

2. FOR ACCEPTANCE TEST

Four (4) pairs – Picked at random from delivery

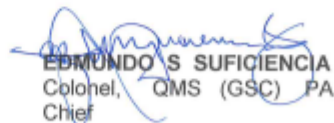
EDMUNDO S SUFICIENCIA
Colonel, QMS (GSC) PA
Chief

Page 1 of 1

Honor. Patriotism. Duty



By 2028, a world class Army that is a source of national pride.

HEADQUARTERS
PHILIPPINE ARMY
OFFICE OF THE ARMY QUARTERMASTER
Fort Andres Bonifacio, Metro Manila

ARMY COMBAT BOOTS, SUEDE, FIELD USE
QM SPEC NR IC-21ACBSFU dtd 05 July 2019

VISUAL INSPECTION CHECKLIST

DESCRIPTION OF DEFECTS	CLASSIFICATION OF DEFECTS
1. Packaging and Packing	
a. Each pair of boots shall be placed on an individual shoe box with onion skin wrapped around each boots for protection	Major
b. The box should have the manufacturer's logo printed on the top	Minor
c. The box label shall have the details such as size and other important matters	Minor
d. The actual boot size shall be the same from the box label	Major
e. Twelve (12) pairs of boots in the shoe box of the same size shall be packed in a corrugated carton	Major
f. Contents of the master box label shall be as specified	Major
2. Shall be Olive Drab in color	
a. Leather	Major
b. Canvas	Major
c. Webbing tapes	Major
d. Laces	Major
e. Outersole and Heel	Major
f. Thread	Major
3. Leather areas outside of the boots shall be flesh-out/suede exposed.	Major
4. Each pair shall have an instruction tag	Major
5. Each pair shall be properly matched	Major
6. Each pair of boots shall have no crooked box toes	Major
7. Each pair of boots shall have no Improper Vulcanization	Major
8. Presence of stains, foreign matter and other defects	
a. Affecting appearance	Major
b. Does not affect appearance	Minor
9. The boots design shall be the same with the official sample of the Philippine Army.	Major
10. Any component part missing	
b. Footbed Cushion/Sock Lining	Major
c. Speed lace loops	Major
d. Eyelets	Major
e. Drainage eyelets	Major
11. Missing contractor's label size	
a. Gusset portion	Major
b. Outersole marking	Minor

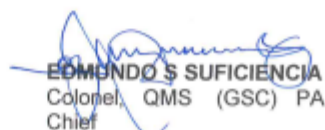
EDMUNDO S. SUFICIENCIA
Colonel, QMS (GSC) PA
Chief

Page 1 of 1

Honor. Patriotism. Duty.



Section VIII. Checklist of Technical and Financial Documents

Checklist of Technical and Financial Documents

I. TECHNICAL COMPONENT ENVELOPE	
<i>Class "A" Documents</i>	
<u>TAB</u>	<u>Legal Documents</u>
A	Valid and updated PhilGEPS Registration Certificate (Platinum Membership) in accordance with Section 8.5.2 of the revised IRR of RA No. 9184 (updated 15 July 2023) and GPPB Resolution 15 - 2021 dated 14 October 2021.
<u>Technical Documents</u>	
B	<p>Duly signed Statement of the prospective bidder of all its ongoing government and private contracts, including contracts awarded but not yet started, if any, whether similar or not similar in nature and complexity to the contract to be bid. (Annex 1)</p> <p>*The bidder may make a reservation under oath in a notarized document not to disclose the name of its client on the ground of an existing confidentiality agreement but must disclose the amount, status, kind of goods, and name of the project for purposes of validating the NFCC, subject to the full disclosure during post-qualification. In this connection, the bidder may keep the name of the client from the statement of ongoing contracts.</p>
C	<p>Statement of the bidder's Single Largest Completed Contract (SLCC) of similar nature within the last five (5) years from the date of the Receipt and Opening of Bid Envelope.</p> <p>Pursuant to Section 23.4.1.3 of the 2016 revised IRR of RA No.9184, the Bidder shall have an SLCC that is at least one (1) contract similar to the Project the value of which, adjusted to current prices using the PSA's CPI, must be at least equivalent to at least twenty-five percent (25%) of the ABC (Expendable Supplies).</p> <p>* For this project, "similar contract or project" shall pertain to the Supply and Delivery of Military Shoes, Rubber Shoes, Boots or other types of footwear.</p>
<u>Financial Documents</u>	
D	<p>The prospective bidder's computation of Net Financial Contracting Capacity (NFCC) (Annex 3-A); or</p> <p>A Committed Line of Credit from a Universal or Commercial Bank in lieu of its NFCC computation (Annex 3-B).</p> <p>* Should the bidder opt to submit NFCC, computation must be at least equal to the ABC to be bid, calculated as follows.</p>

	<p>NFCC = [(Current assets minus current liabilities) (15)] minus the value of all ongoing contracts, including awarded contracts yet to be started.</p> <p>* The values of the domestic bidder's current assets and current liabilities shall be based on the latest Annual Income Tax Return and Audited Financial Statements filed thru eFPS.</p> <p>* For foreign bidders, the value of the current assets and current liabilities shall be based on their latest Audited Financial Statements (AFS) prepared in accordance with international reporting standards. The NFCC computation shall be expressed in Philippine Peso based on the prevailing exchange rate as published in the BSP reference rate bulletin on the date of preparation of the AFS.</p> <p>* If the prospective bidder opts to submit a Committed Line of Credit, it must be at least equal to ten percent (10%) of the ABC of the project issued by local universal or commercial bank. The amount of Committed Line of Credit must be Machine Validated.</p>
<i>Class "B" Documents</i>	
E	<p>Duly signed Joint Venture Agreement (JVA) in case the joint venture is already in existence; <u>or</u></p> <p>In the absence of a JVA, duly Notarized Statement/s from all the potential joint venture partners stating that they will enter into and abide by the provisions of the JVA in the instance that the bid is successful. Failure to enter into a joint venture in the event of a contract award shall be ground for the forfeiture of the bid security; <u>or</u></p> <p>In case JVA is not applicable, the bidder must submit a duly signed Statement stating that JVA is not applicable in lieu of the foregoing (Annex 4).</p> <p>*Note:</p> <ul style="list-style-type: none"> • The JVA should be specific to the project including the purpose and all supporting documents related thereto.
F	Bid security in the prescribed form, amount and validity period; <u>or</u> a Notarized Bid Securing Declaration (Annex 5) .
G	<p>Conformity with the Schedule of Requirements (Annex 6-A).</p> <p>Duly signed statement of compliance to Technical Specifications and Test and Evaluation Procedures (Annex 6-B).</p> <p>Warranty Undertaking (Annex 6-C).</p> <p>Certificate of Replacement for Defective Items (Annex 6-D).</p>
H	Certificate from Armed Forces of the Philippines Procurement Service (AFPPS) that the Bidder is not Blacklisted and has no overdue delivery ; <u>or</u>

	<p>In the absence of the said Certificate, the Bidder shall submit a proof of application of the same stamped received by AFPPS if manually filed, or acknowledged received by the AFPPS through its official email address:afppsthree@gmail.com if electronically filed.</p> <p>*Note:</p> <ul style="list-style-type: none"> • In case of Joint Venture, each JV partner shall submit the Certificate.
I	Notarized Omnibus Sworn Statement (Annex 7) .
J	<p>Proof of Authority of the designated representative/s for purposes of the bidding</p> <p><u>For Local Bidder:</u></p> <p>a. Duly notarized Special Power of Attorney – For Sole Proprietorship if owner opts to designate a representative/s; OR</p> <p>b. Duly notarized Secretary’s Certificate evidencing the authority of the designated representative/s, issued by the corporation, cooperative or the members of the joint venture.</p> <p><u>For Foreign Bidder:</u></p> <p>a. Valid and Current Written Appointment of the Philippine based company (as local representative of foreign manufacturer) issued by the foreign bidder. The written appointment must include detailed scope of responsibility of the local representative. A Certified True Copy of the Written Appointment may be submitted subject to the presentation of the original document during post qualification; AND</p> <p>b. Duly Notarized authorization of the duly registered Philippine-based company representative(e.g. Secretary’s Certificate for Corporation, Special Power of Attorney for Sole Proprietor) with specimen signature of the authorized representative to transact with PA/AFP including address, telephone number, mobile phone number, and email address;</p> <p>OR</p> <p>c. <i>In case the authorized local representative is an individual (citizen of the Philippines), a Valid and Current Written Appointment of the said individual as the local representative issued by the foreign bidder must be submitted.</i> The written appointment must include detailed scope of responsibility of the local representative with specimen signature of the authorized representative to transact with PA/AFP, including address, telephone number, mobile phone number, and email address. A Certified True Copy of the Written Appointment may be submitted subject to the presentation of the original document during post qualification.</p>

	<p><i>Note 1 (for both local and foreign bidders): Provided that in the case of unincorporated joint venture, each member shall submit their respective Special Power of Attorney and/or Secretary's Certificate evidencing the authority of the designated representatives for purposes of this bidding</i></p> <p><i>Note 2 (for both local and foreign bidders): The Secretary's Certificate, Board Resolution or Special Power of Attorney, or its equivalent document/proof of authority of the designated representative/s for purposes of the bidding, must have a specimen signature of the bidder or its authorized representative; it must indicate in the said document the authority to transact with the Philippine Army/AFP; it must be specific to the project; and it must indicate in the same document the address, telephone number, mobile phone number, and email address of the bidder or its authorized representative.</i></p> <p><i>Note 3 (for both local and foreign bidders): In case of Joint Venture, bidder must submit an Original Special Power of Attorney wherein all members of the Joint Venture are signatories, giving full power and authority to the designated representative of the Joint Venture to sign the OSS and to do acts to represent the bidder.</i></p>
K	Valid and Updated BOI Accreditation in compliance with R.A. 9290 otherwise known as "The Footwear, Leather Goods and Tannery Industries Development Act"

II. FINANCIAL COMPONENT ENVELOPE

<u>TAB</u>	<u>Financial Documents</u>
A	Bid Form for the Procurement of Goods (Annex 8-A)
	Duly signed and accomplished Financial Bid Form (Annex 8-B)
B	Duly signed and accomplished Price Schedule(s) (Annex 9)

Bidding Forms

Bidding Forms	Annex Nr
Statement of All On-going Government and Private Contracts including Contracts Awarded but not yet started, if any.	Annex 1
Statement of Single Largest Similar Completed Contract within the last five (5) years from date of submission and receipt of bids equivalent to at least twenty-five (25%) of the ABC	Annex 2
Certificate of Net Financial Contracting Capacity (NFCC)	Annex 3-A
Sample Form for Committed Line of Credit	Annex 3-B
Statement that JVA is not applicable	Annex 4
Bid Securing Declaration	Annex 5
Conformity with the Schedule of Requirements	Annex 6-A
Duly signed statement of compliance to Technical Specifications and Test and Evaluation Procedures	Annex 6-B
Warranty Undertaking	Annex 6-C
Certificate of Replacement for Defective Items	Annex 6-D
Omnibus Sworn Statement	Annex 7
Bid Form for the Procurement of Goods	Annex 8-A
Duly signed and Accomplished Financial Bid Form	Annex 8-B
Bid Prices and applicable Price Schedules	Annex 9

Annex 1

(COMPANY LETTERHEAD)

**Procurement of 71,018 pairs
Army Combat Boots, Suede, Field Use
Bid Ref. No. QM PABAC1 002-24
Approved Budget Contract: Php198,850,400.00**

Statement of **All On-going Government and Private Contracts** including Contracts
Awarded but not yet started, if any.

1. All On-going Government Contracts

Name of Contract	Date of Contract	Kinds of Goods	Value of Contract	Status of Contract	Date of Delivery	Purchase Order, Notice to Proceed or Contract	Value of Outstanding Contract
TOTAL							

Total Value of Outstanding Contract: _____

2. All On-going Private Contracts

Name of Contract	Date of Contract	Kinds of Goods	Value of Contract	Status of Contract	Date of Delivery	Purchase Order, Notice to Proceed or Contract	Value of Outstanding Contract
TOTAL							

Total Value of Outstanding Contract: _____

CERTIFIED CORRECT:

Name & Signature of Authorized Representative

Position

Date

Annex 2

(Company Letterhead)

**Procurement of 71,018 pairs
Army Combat Boots, Suede, Field Use
Bid Ref. No. QM PABAC1 002-24
Approved Budget Contract: Php198,850,400.00**

Statement of Single Largest Similar Completed Contract within the last five (5) years from date of submission and receipt of bids equivalent to at least twenty-five (25%) of the ABC

Name of Contract	Date of Contract	Kinds of Goods	Value of Contract	Date of Delivery	End-User's Acceptance or Official Receipts

CERTIFIED CORRECT:

Name & Signature of Authorized Representative

Position

Date

Annex 3-A

CERTIFICATE OF NET FINANCIAL CONTRACTING CAPACITY*(Please show figures at how you arrived at the NFCC)*

This is to certify that our **Net Financial Contracting Capacity (NFCC)** is **Philippine Pesos** _____ (P _____) which is at least equal to the total ceiling price we are bidding.

The amount is computed as follows: **NFCC= (CA-CL) (K)-C**

Where:

CA = Current Assets

CL = Current Liabilities

K = 15

C = value of all outstanding or uncompleted portions of the projects under ongoing contracts, including awarded contracts yet to be started coinciding with the contract for this Project

Issued this _____ day of _____, 2022.

CERTIFIED CORRECT:

Name & Signature of Authorized Representative

Position

Date

Annex 3-B

**(Name of Bank)
COMMITTED LINE OF CREDIT**

Date: _____

**ARMED FORCES OF THE PHILIPPINES
OFFICE OF THE PHILIPPINE ARMY BIDS AND AWARDS COMMITTEE
Fort Andres Bonifacio, Metro Manila**

PROJECT : _____
 COMPANY/FIRM : _____
 ADDRESS : _____
 BANK/FINANCING INSTITUTION : _____
 ADDRESS : _____
 AMOUNT : _____

This is to certify that the above Bank/Financing Institution with business address indicated above, commits to provide the (Supplier/Distributor/Manufacturer), if awarded the above-mentioned Contract, a credit line in the amount specified above which shall be exclusively used to finance the performance of the above-mentioned contract subject to our terms, conditions and requirements.

The credit line shall be available on the date of the submission of bid by the (Supplier/Distributor/Manufacturer) and such line of credit shall be maintained until the project is completed by the Contractor.

This certification is being issued in favor of said (Supplier/Distributor/Manufacturer) in connection with the bidding requirement of (Name of Procuring Entity) for the above-mentioned Contract. We are aware that any false statements issued by us make us liable for perjury.

The committed line of credit cannot be terminated or cancelled without the prior written approval of the OFFICE OF THE PHILIPPINE ARMY BIDS AND AWARDS COMMITTEE.

 Name and Signature of Authorized Financing Institution Office

 Official Designation

Concurred By:

 Name & Signature of (Supplier/Distributor/Manufacturer's) Authorized Representative

 Official Designation

SUBSCRIBED AND SWORN TO BEFORE ME this _____ day of _____ at _____, Philippines. Affiant exhibited to me his/her competent Evidence of identity as

defined by the 2004 Rules on Notarial Practice (A.M. No. 02-8-13-SC), issued on _____ at _____.

NOTARY PUBLIC

Doc No: _____
Page No: _____
Book No: _____
Series of: _____

Annex 4

(Company Letterhead)

**Procurement of 71,018 pairs
Army Combat Boots, Suede, Field Use
Bid Ref. No. QM PABAC1 002-24
Approved Budget Contract: Php198,850,400.00**

This is to certify that _____ (name of bidder) _____ will be participating **without a joint venture partner** in the procurement of _____ (name of project) _____.

Further, the undersigned acknowledges that **Joint Venture Agreement is Not Applicable** for the above mentioned project.

CERTIFIED CORRECT:

Name & Signature of Authorized Representative

Position

Date

Annex 5

Name of Project: _____
Public Bidding Nr: _____
ABC: _____

BID-SECURING DECLARATION

REPUBLIC OF THE PHILIPPINES)
CITY OF

BID-SECURING DECLARATION

Invitation to Bid/Request for Expression of Interest No. 1: (Insert reference number)

To: (Insert name and address of the Procuring Entity)

I/We, the undersigned, declare that:

1. I/We understand that, according to your conditions, bids must be supported by a Bid Security, which may be in the form of a Bid-Securing Declaration.

2. I/We accept that: (a) I/We will be automatically disqualified from bidding for any contract with any procuring entity for a period of two (2) years upon receipt of your Blacklisting Order; and (b) I/We will pay the applicable fine provided under Section 6 of the Guidelines on the Use of Bid Securing Declarations, within fifteen (15) days from receipt of the written demand by the procuring entity for the commission of acts resulting to the enforcement of the bid securing declaration under Sections 23.1 (b), 34.2, 40.1 and 69.1, except 69.1 (f) of the IRR of RA 9184; without prejudice to other legal action the government may undertake.

3. I/We understand that this Bid-Securing Declaration shall cease to be valid on the following circumstances:

a) Upon expiration of the bid validity period, or any extension thereof pursuant to your request;

b) I am/we are declared ineligible or post-disqualified upon receipt of your notice to such effect, and (i) I/We failed to timely file a request for consideration or (ii) I/We filed a waiver to avail of said right;

c) I am/were declared as the bidder with the Lowest Calculated and Responsive Bid/Highest Rated and Responsive Bids, and I/We have furnished the performance security and signed the Contract.

IN WITNESS WHEREOF, I/We hereunto set my/our hand/s this _____ day of (Month) (Year) at (Place of Execution).

NAME OF BIDDERS AUTHORIZED REPRESENTATIVE

(Insert signatory's legal capacity)

AFFIANT

SUBSCRIBED AND SWORN TO BEFORE ME this _____ day of _____ at _____, Philippines. Affiant exhibited to me his/her competent Evidence of identity as

defined by the 2004 Rules on Notarial Practice (A.M. No. 02-8-13-SC), issued on _____ at _____.

NOTARY PUBLIC

Doc No: _____
Page No: _____
Book No: _____
Series of: _____

Annex 6-A

SCHEDULE OF REQUIREMENTS

**Procurement of 71,018 pairs
Army Combat Boots, Suede, Field Use
Bid Ref. No. QM PABAC1 002-24
Approved Budget Contract: Php198,850,400.00**

TO THE BIDDER: Indicate **“COMPLY”** if proposal meets the technical specifications and project requirements. **DO NOT LEAVE ANY BLANK. A “YES OR NO” ENTRY WILL NOT BE ACCEPTED. FAILURE TO CONFORM WILL RESULT IN A RATING OF “FAILED”**

Description	Quantity	Delivery Period	Delivery Place	Bidders Proposal
Army Combat Boots, Suede, Field Use	28,478 pairs	Full Delivery within One Hundred Sixty (160) Calendar Days upon Receipt of NTP	GS Warehouse, 1LSG, Army Support Command, PA, Camp General Servillano Aquino, San Miguel, Tarlac City	
	42,540 pairs		GS Warehouse, 2LSG, ASCOM, PA, Camp General Arturo Enrile, Malagutay, Zamboanga City	

CERTIFIED CORRECT:

Name & Signature of Authorized Representative

Position

Date

Annex 6-B

COMPLIANCE TO TECHNICAL SPECIFICATION

**Procurement of 71,018 pairs
Army Combat Boots, Suede, Field Use
Bid Ref. No. QM PABAC1 002-24
Approved Budget Contract: Php198,850,400.00**

TO THE BIDDER: Indicate “COMPLY” If proposal meets the technical specifications and project requirements. DO NOT LEAVE ANY BLANK. A “YES OR NO” ENTRY WILL NOT BE ACCEPTED. FAILURE TO CONFORM WILL RESULT IN A RATING OF “FAILED”.		
Quantity/Item Description	Required Technical Specifications/Test Parameters	Bidder's Proposal
71,018 pairs Army Combat Boots, Suede, Field Use	QM SPEC NR IC – 21ACBSFU dated 05 July 2019	

I/WE, the undersigned bidder, have examined the Bidding Documents including Bid Bulletins, as applicable, hereby OFFER to (supply/deliver/perform) the above described items.

I/WE undertake, if our bid is accepted, to deliver the items in accordance with the terms and conditions contained in the bid documents, including the posting of the required performance security **within ten (10) calendar days** from receipt of the Notice of Award.

Until a formal contract/order confirmation is prepared and signed, this Bid is binding on us.

Name of Company

Signature of Company Representative

Name & Designation

Date

Annex 6-C

(Bidder's Company Letterhead)

WARRANTY UNDERTAKING

**Procurement of 71,018 pairs
Army Combat Boots, Suede, Field Use
Bid Ref. No. QM PABAC1 002-24
Approved Budget Contract: Php198,850,400.00**

I/We, _____ (Name) _____, _____ (Title/Capacity) _____, the duly authorized representative of _____ (Company/Bidder) _____, hereby commits that should we be awarded the contract, we will issue a Warranty Certificate in favor of the Philippine Army (PA) valid for **six (6) months** from date of final acceptance.

This Undertaking shall form part of the Technical Requirements for the aforesaid procurement project

Signature of Company Representative

Name & Designation

Date

Annex 6-D

(Bidder's Company Letterhead)

**CERTIFICATE OF REPLACEMENT FOR DEFECTIVE
ITEMS**

**Procurement of 71,018 pairs
Army Combat Boots, Suede, Field Use
Bid Ref. No. QM PABAC1 002-24
Approved Budget Contract: Php198,850,400.00**

I/We, _____ (Name) _____, _____ (Title/Capacity) _____, the duly authorized representative of _____ (Company/Bidder) _____, hereby commits that should we be awarded the contract, we will replace all defective items **within thirty (30) calendar days** upon receipt of Notice of Defects from the Philippine Army.

Supplier further certifies that the goods to be delivered have been manufactured **not more than six (6) months** from the date of delivery.

This Certification shall form part of the Technical Requirements for the aforesaid procurement project.

Issued this _____ day of _____ 2023 in _____, Philippines

Name of Company (Bidder)

Full Name of Authorized Representative

Address

Signature of Authorized Representative

Tel. No./Fax

E-mail Address

Annex 7

Omnibus Sworn Statement (Revised)*[shall be submitted with the Bid]*

REPUBLIC OF THE PHILIPPINES)
 CITY/MUNICIPALITY OF _____) S.S.

AFFIDAVIT

I, [Name of Affiant], of legal age, [Civil Status], [Nationality], and residing at [Address of Affiant], after having been duly sworn in accordance with law, do hereby depose and state that:

1. *[Select one, delete the other:]*

[If a sole proprietorship:] I am the sole proprietor or authorized representative of [Name of Bidder] with office address at [address of Bidder];

[If a partnership, corporation, cooperative, or joint venture:] I am the duly authorized and designated representative of [Name of Bidder] with office address at [address of Bidder];

2. *[Select one, delete the other:]*

[If a sole proprietorship:] As the owner and sole proprietor, or authorized representative of [Name of Bidder], I have full power and authority to do, execute and perform any and all acts necessary to participate, submit the bid, and to sign and execute the ensuing contract for [Name of the Project] of the [Name of the Procuring Entity], as shown in the attached duly notarized Special Power of Attorney;

[If a partnership, corporation, cooperative, or joint venture:] I am granted full power and authority to do, execute and perform any and all acts necessary to participate, submit the bid, and to sign and execute the ensuing contract for [Name of the Project] of the [Name of the Procuring Entity], as shown in the attached [state title of attached document showing proof of authorization (e.g., duly notarized Secretary's Certificate, Board/Partnership Resolution, or Special Power of Attorney, whichever is applicable)];

3. [Name of Bidder] is not "blacklisted" or barred from bidding by the Government of the Philippines or any of its agencies, offices, corporations, or Local Government Units, foreign government/foreign or international financing institution whose blacklisting rules have been recognized by the Government Procurement Policy Board, **by itself or by relation, membership, association, affiliation, or controlling interest with another blacklisted person or entity as defined and provided for in the Uniform Guidelines on Blacklisting;**

4. Each of the documents submitted in satisfaction of the bidding requirements is an authentic copy of the original, complete, and all statements and information provided therein are true and correct;

5. [Name of Bidder] is authorizing the Head of the Procuring Entity or its duly authorized representative(s) to verify all the documents submitted;

6. *[Select one, delete the rest:]*

[If a sole proprietorship:] The owner or sole proprietor is not related to the Head of the Procuring Entity, members of the Bids and Awards Committee (BAC), the Technical Working Group, and the BAC Secretariat, the head of the Project Management Office or the end-user unit, and the project consultants by consanguinity or affinity up to the third civil degree;

[If a partnership or cooperative:] None of the officers and members of [Name of Bidder] is related to the Head of the Procuring Entity, members of the Bids and Awards Committee (BAC), the Technical Working Group, and the BAC Secretariat, the head of the Project Management Office or the end-user unit, and the project consultants by consanguinity or affinity up to the third civil degree;

[If a corporation or joint venture:] None of the officers, directors, and controlling stockholders of [Name of Bidder] is related to the Head of the Procuring Entity, members of the Bids and Awards Committee (BAC), the Technical Working Group, and the BAC Secretariat, the head of the Project Management Office or the end-user unit, and the project consultants by consanguinity or affinity up to the third civil degree;

7. [Name of Bidder] complies with existing labor laws and standards; and
8. [Name of Bidder] is aware of and has undertaken the responsibilities as a Bidder in compliance with the Philippine Bidding Documents, which includes:
 - a. Carefully examining all of the Bidding Documents;
 - b. Acknowledging all conditions, local or otherwise, affecting the implementation of the Contract;
 - c. Making an estimate of the facilities available and needed for the contract to be bid, if any; and
 - d. Inquiring or securing Supplemental/Bid Bulletin(s) issued for the [Name of the Project].
9. [Name of Bidder] did not give or pay directly or indirectly, any commission, amount, fee, or any form of consideration, pecuniary or otherwise, to any person or official, personnel or representative of the government in relation to any procurement project or activity.

10. **In case advance payment was made or given, failure to perform or deliver any of the obligations and undertakings in the contract shall be sufficient grounds to constitute criminal liability for Swindling (Estafa) or the commission of fraud with unfaithfulness or abuse of confidence through misappropriating or converting any payment received by a person or entity under an obligation involving the duty to deliver certain goods or services, to the prejudice of the public and the government of the Philippines pursuant to Article 315 of Act No. 3815 s. 1930, as amended, or the Revised Penal Code.**

[Jurat]

[Format shall be based on the latest Rules on Notarial Practice]

IN WITNESS WHEREOF, I have hereunto set my hand this ___ day of ___, 20___
at _____, Philippines.

Bidder’s Representative/Authorized Signatory

SUBSCRIBED AND SWORN TO BEFORE ME this _____day of _____ at
_____, Philippines. Affiant exhibited to me his/her competent Evidence of identity as
defined by the 2004 Rules on Notarial Practice (A.M. No. 02-8-13-SC), issued on
_____ at _____.

NOTARY PUBLIC

Doc No: _____
Page No: _____
Book No: _____
Series of: _____

Annex 8-A

Bid Form for the Procurement of Goods
[shall be submitted with the Bid]

BID FORM

Date: _____

Project Identification No.: _____

To: *[name and address of Procuring Entity]*

Having examined the Philippine Bidding Documents (PBDs) including the Supplemental or Bid Bulletin Numbers *[insert numbers]*, the receipt of which is hereby duly acknowledged, we, the undersigned, offer to *[supply/deliver/perform]* *[description of the Goods]* in conformity with the said PBDs for the sum of *[total Bid amount in words and figures]* or the total calculated bid price, as evaluated and corrected for computational errors, and other bid modifications in accordance with the Price Schedules attached herewith and made part of this Bid. The total bid price includes the cost of all taxes, such as, but not limited to: *[specify the applicable taxes, e.g. (i) value added tax (VAT), (ii) income tax, (iii) local taxes, and (iv) other fiscal levies and duties]*, which are itemized herein or in the Price Schedules,

If our Bid is accepted, we undertake:

- a. to deliver the goods in accordance with the delivery schedule specified in the Schedule of Requirements of the Philippine Bidding Documents (PBDs);
- b. to provide a performance security in the form, amounts, and within the times prescribed in the PBDs;
- c. to abide by the Bid Validity Period specified in the PBDs and it shall remain binding upon us at any time before the expiration of that period.

[Insert this paragraph if Foreign-Assisted Project with the Development Partner:

Commissions or gratuities, if any, paid or to be paid by us to agents relating to this Bid, and to contract execution if we are awarded the contract, are listed below:

Name and address of agent	Amount and Purpose	Currency	Commission or gratuity
---------------------------	--------------------	----------	------------------------

(if none, state "None")]

Until a formal Contract is prepared and executed, this Bid, together with your written acceptance thereof and your Notice of Award, shall be binding upon us.

We understand that you are not bound to accept the Lowest Calculated Bid or any Bid you may receive.

We certify/confirm that we comply with the eligibility requirements pursuant to the PBDs.

The undersigned is authorized to submit the bid on behalf of *[name of the bidder]* as evidenced by the attached *[state the written authority]*.

We acknowledge that failure to sign each and every page of this Bid Form, including the attached Schedule of Prices, shall be a ground for the rejection of our bid.

Name: _____ Legal capacity: _____ Signature: _____
Duly authorized to sign the Bid for and behalf of: _____ Date: _____

Annex 8-B**(Bidder's Company Letterhead)**

**Procurement of 71,018 pairs
Army Combat Boots, Suede, Field Use
Bid Ref. No. QM PABAC1 002-24
Approved Budget Contract: Php198,850,400.00**

FINANCIAL BID FORM

Description	Qty	ABC Price		Bidder's Proposal	
		U/P	Total Price	U/P	Total Price
Army Combat Boots, Suede, Field Use	71,018 pairs	Php2,800.00	Php198,850,400.00		
TOTAL BID PRICE					
Total Bid Price (Amount in Words):					
BIDDER'S UNDERTAKING					
I/We, the undersigned bidder, having examined the Bidding Documents including Bid Bulletins, as applicable, hereby OFFER to (supply/deliver/perform) the above-described items.					
I/We undertake, if our bid is accepted, to deliver the items in accordance with the terms and conditions contained in the bid documents, including the posting of the required performance security within ten (10) calendar days from receipt of Notice of Award.					
Until a formal contract/order confirmation is prepared and signed, this Bid is binding on us.					

Name of Company (in print)

Signature of Company Representative

Name & Designation (in print)

Date

Annex 9
FORM NO. 1

(Bidder's Company Letterhead)

Procurement of 71,018 pairs
Army Combat Boots, Suede, Field Use
Bid Ref. No. QM PABAC1 002-24
Approved Budget Contract: Php198,850,400.00

For Goods Offered From Abroad

Name of Bidder _____ Invitation to Bid¹ Number ____ Page ____ of _____.

1	2	3	4	5	6	7	8	9
Item	Description	Country of origin	Qty	Unit price CIF port of entry (specify port) or CIF named place (specify border point or place of destination)	Total CIF or CIP price per item (col. 4 x 5)	Unit Price Delivered at Place (DAP)	Unit price Delivered Duty Paid (DDP)	Total Price -(if DAP col 4X7) -(If DDP col 4X8)

Note: If the particular column is not applicable indicate **dash (-)** or **zero (0)**, as applicable.

[signature]

[in the capacity of]

Duly authorized to sign Bid for and

¹ If ADB, JICA and WB funded projects, use IFB.

Annex 9
FORM NO. 2

(Bidder’s Company Letterhead)

**Procurement of 71,018 pairs
Army Combat Boots, Suede, Field Use
Bid Ref. No. QM PABAC1 002-24
Approved Budget Contract: Php198,850,400.00**

For Goods Offered From Within the Philippines

Name of Bidder _____ Invitation to Bid² Number _ Page _ of ____.

1	2	3	4	5	6	7	8	9	10
Item	Description	Country of origin	Quantity	Unit price EXW per item	Transportation and Insurance and all other costs incidental to delivery, per item	Sales and other taxes payable if Contract is awarded, per item	Cost of Incidental Services, if applicable, per item	Total Price, per unit (col 5+6+7+8)	Total Price delivered Final Destination (col 9) x (col 4)

Note: If the particular column is not applicable indicate **dash (-)** or **zero (0)**, as applicable.

[signature]

[in the capacity of]

Duly authorized to sign Bid for and on behalf of _____

² If ADB, JICA and WB funded projects, use IFB.

