



HEADQUARTERS
PHILIPPINE ARMY
OFFICE OF THE PHILIPPINE ARMY SPECIAL BIDS AND AWARD COMMITTEE
11TH Infantry (Alakdan) Division, PA
Kuta Heneral Teodulfo Bautista, Busbus, Jolo, Sulu

BIDDING DOCUMENT

for the

**Construction of GSMO Quarters
at 11ID, PA, Camp Bautista,
Busbus, Jolo, Sulu**

11ID SBAC 012-24

Date of Issuance: 19 June 2024

ABC: PhP4,988,913.00

TABLE OF CONTENTS

| | |
|--|-----------|
| Glossary of Terms, Abbreviations, and Acronyms | 6 |
| Section I. Invitation to Bid | 6 |
| Section II. Instructions to Bidders | 7 |
| 1. Scope of Bid | 11 |
| 2. Funding Information | 11 |
| 3. Bidding Requirements | 11 |
| 4. Corrupt, Fraudulent, Collusive, Coercive, and Obstructive Practices | 11 |
| 5. Eligible Bidders | 12 |
| 6. Origin of Associated Goods..... | 12 |
| 7. Subcontracts | 12 |
| 8. Pre-Bid Conference..... | 12 |
| 9. Clarification and Amendment of Bidding Documents | 12 |
| 10. Documents Comprising the Bid: Eligibility and Technical Components..... | 13 |
| 11. Documents Comprising the Bid: Financial Component | 13 |
| 12. Alternative Bids | 14 |
| 13. Bid Prices | 14 |
| 14. Bid and Payment Currencies..... | 14 |
| 15. Bid Security | 14 |
| 16. Sealing and Marking of Bids..... | 14 |
| 17. Deadline for Submission of Bids | 15 |
| 18. Opening and Preliminary Examination of Bids | 15 |
| 19. Detailed Evaluation and Comparison of Bids | 15 |
| 20. Post Qualification | 15 |
| 21. Signing of the Contract..... | 15 |
| Section III. Bid Data Sheet..... | 17 |
| Section IV. General Conditions of Contract..... | 22 |
| 1. Scope of Contract | 23 |
| 2. Sectional Completion of Works | 23 |
| 3. Possession of Site..... | 23 |
| 4. The Contractor's Obligations..... | 23 |
| 5. Performance Security..... | 24 |

| | | |
|---|--|-----------|
| 6. | Site Investigation Reports | 24 |
| 7. | Warranty..... | 24 |
| 8. | Liability of the Contractor..... | 24 |
| 9. | Termination for Other Causes | 24 |
| 10. | Dayworks | 25 |
| 11. | Program of Work..... | 25 |
| 12. | Instructions, Inspections and Audits | 25 |
| 13. | Advance Payment | 25 |
| 14. | Progress Payments..... | 25 |
| 15. | Operating and Maintenance Manuals..... | 25 |
| Section V. Special Conditions of Contract..... | | 27 |
| Section VI. Specifications | | 30 |
| Section VII. Drawings | | 35 |
| Section VIII. Bill of Quantities | | 41 |
| Section IX. Checklist of Technical and Financial Documents | | 57 |

Glossary of Terms, Abbreviations, and Acronyms

ABC – Approved Budget for the Contract.

ARCC – Allowable Range of Contract Cost.

BAC – Bids and Awards Committee.

Bid – A signed offer or proposal to undertake a contract submitted by a bidder in response to and in consonance with the requirements of the bidding documents. Also referred to as *Proposal* and *Tender*. (2016 revised IRR, Section 5[c])

Bidder – Refers to a contractor, manufacturer, supplier, distributor and/or consultant who submits a bid in response to the requirements of the Bidding Documents. (2016 revised IRR, Section 5[d])

Bidding Documents – The documents issued by the Procuring Entity as the bases for bids, furnishing all information necessary for a prospective bidder to prepare a bid for the Goods, Infrastructure Projects, and/or Consulting Services required by the Procuring Entity. (2016 revised IRR, Section 5[e])

BIR – Bureau of Internal Revenue.

BSP – Bangko Sentral ng Pilipinas.

CDA – Cooperative Development Authority.

Consulting Services – Refer to services for Infrastructure Projects and other types of projects or activities of the GOP requiring adequate external technical and professional expertise that are beyond the capability and/or capacity of the GOP to undertake such as, but not limited to: (i) advisory and review services; (ii) pre-investment or feasibility studies; (iii) design; (iv) construction supervision; (v) management and related services; and (vi) other technical services or special studies. (2016 revised IRR, Section 5[i])

Contract – Refers to the agreement entered into between the Procuring Entity and the Supplier or Manufacturer or Distributor or Service Provider for procurement of Goods and Services; Contractor for Procurement of Infrastructure Projects; or Consultant or Consulting Firm for Procurement of Consulting Services; as the case may be, as recorded in the Contract Form signed by the parties, including all attachments and appendices thereto and all documents incorporated by reference therein.

Contractor – is a natural or juridical entity whose proposal was accepted by the Procuring Entity and to whom the Contract to execute the Work was awarded. Contractor as used in these Bidding Documents may likewise refer to a supplier, distributor, manufacturer, or consultant.

CPI – Consumer Price Index.

DOLE – Department of Labor and Employment.

DTI – Department of Trade and Industry.

Foreign-funded Procurement or Foreign-Assisted Project – Refers to procurement whose funding source is from a foreign government, foreign or international financing

institution as specified in the Treaty or International or Executive Agreement. (2016 revised IRR, Section 5[b]).

GFI – Government Financial Institution.

GOCC –Government-owned and/or –controlled corporation.

Goods – Refer to all items, supplies, materials and general support services, except Consulting Services and Infrastructure Projects, which may be needed in the transaction of public businesses or in the pursuit of any government undertaking, project or activity, whether in the nature of equipment, furniture, stationery, materials for construction, or personal property of any kind, including non-personal or contractual services such as the repair and maintenance of equipment and furniture, as well as trucking, hauling, janitorial, security, and related or analogous services, as well as procurement of materials and supplies provided by the Procuring Entity for such services. The term “related” or “analogous services” shall include, but is not limited to, lease or purchase of office space, media advertisements, health maintenance services, and other services essential to the operation of the Procuring Entity. (2016 revised IRR, Section 5[r])

GOP – Government of the Philippines.

Infrastructure Projects – Include the construction, improvement, rehabilitation, demolition, repair, restoration or maintenance of roads and bridges, railways, airports, seaports, communication facilities, civil works components of information technology projects, irrigation, flood control and drainage, water supply, sanitation, sewerage and solid waste management systems, shore protection, energy/power and electrification facilities, national buildings, school buildings, hospital buildings, and other related construction projects of the government. Also referred to as *civil works or works*. (2016 revised IRR, Section 5[u])

LGUs – Local Government Units.

NFCC – Net Financial Contracting Capacity.

NGA – National Government Agency.

PCAB – Philippine Contractors Accreditation Board.

PhilGEPS - Philippine Government Electronic Procurement System.

Procurement Project – refers to a specific or identified procurement covering goods, infrastructure project or consulting services. A Procurement Project shall be described, detailed, and scheduled in the Project Procurement Management Plan prepared by the agency which shall be consolidated in the procuring entity's Annual Procurement Plan. (GPPB Circular No. 06-2019 dated 17 July 2019)

PSA – Philippine Statistics Authority.

SEC – Securities and Exchange Commission.

SLCC – Single Largest Completed Contract.

UN – United Nations.

Section I. Invitation to Bid

HEADQUARTERS
PHILIPPINE ARMY
Kuta Heneral Teodulfo Bautista, Busbus, Jolo, Sulu

INVITATION TO BID FOR

Construction of Chief of Staff Quarters at 11ID, PA, Camp Bautista, Busbus, Jolo, Sulu

1. The **Philippine Army**, through the **Certificate of Funding Chargeability** signed by **LTC GABRIEL D TAYKO (CE) PA, AC of S for Financial Management, G10, 54EBde, PA** noted by **BGEN RANDY F FAJILAGUTAN PA, Commander, 54EBde, PA** under **Advice of Sub-Allotment Numbers 5400-2024-0105** intends to apply the sum of **Four Million Nine Hundred Eighty-Eight Thousand Nine Hundred Thirteen Pesos (PhP4,988,913.00)** only being the Approved Budget for the Contract (ABC) to payments under the contract for **Construction of GSMO Quarters at 11ID, PA, Camp Bautista, Busbus, Jolo, Sulu** under Bid Reference No: **11ID SBAC 010-24**. Bids received in excess of the ABC shall be automatically rejected at bid opening.
2. The **Philippine Army** now invites bids for the above Procurement Project. Completion of the work is **required One Hundred Twenty (120) Calendar days** reckoned from the date of receipt of Notice to Proceed (NTP) or Notice of Site Possession whichever comes later. Bidders should have completed a contract similar to the Project. The description of an eligible bidder is contained in the Bidding Documents, particularly, in Section II (Instructions to Bidders).
3. Bidding will be conducted through open competitive bidding procedures using non-discretionary "*pass/fail*" criterion as specified in the 2016 revised Implementing Rules and Regulations (IRR) of Republic Act (RA) No. 9184.
4. Interested bidders may obtain further information from **Philippine Army** and inspect the Bidding Documents at the address given below during **Office Hours from 8:00am to 5:00pm except Holidays**.
5. A complete set of Bidding Documents may be acquired by interested bidders on **19 June 2024** from given address and website/s below and upon payment of the applicable fee for the Bidding Documents, pursuant to the latest Guidelines issued by the GPPB, in the amount of **Five Thousand Pesos (PhP5,000.00)** only. The Procuring Entity shall allow the bidder to present its proof of payment for the fees in person during submission of bids.
6. The **Philippine Army** will hold a Pre-Bid Conference on **09:30am, 26 June 2024** at **Hqs, 54EBde, PA, Cabatangan, Zamboanga City** which shall be open to prospective bidders. However, each bidder is allowed only ONE representative to enter the venue. Others can participate thru the following zoom link (to be provided before start of the Pre-Bid Conference).

7. Bids must be duly received by the SBAC Secretariat through manual submission at **Hqs, 54EBde, PA, Cabatangan, Zamboanga City**, on or before **09:30am, 10 July 2024**. Late bids shall not be accepted.
8. All bids must be accompanied by a bid security in any of the acceptable forms and in the amount stated in **ITB Clause 15.1**.
9. Bid opening shall be on **09:30am** onwards, **10 July 2024 at Hqs, 54EBde, PA, Cabatangan, Zamboanga City**. Bids will be opened in the presence of the bidders' representatives physically.

10. The schedule of the bidding activities shall be as follows:

| ACTIVITIES | TIME | VENUE |
|--|---|---|
| 1. Sale and Issuance of Bidding Documents | 8:00 am to 5:00 pm only Mondays - Fridays starting Date: 19 June – 10 July 2024 | 115th Satellite Contracting Office, AFPPS, Camp Gen Arturo Enrile, Malagutay, Zamboanga City BGEN ALEXEI C MUSÑGI PA Chairperson Contact Person: LTC MICHAEL B DE GUIA (CE) PA Head Secretariat, 11ID SBAC Cp Nr.: +639178168598 Email address: 115 th 11id@gmail.com |
| 2. Pre-Bid Conference | Date: 26 June 2024 09:30 AM | Hqs, 54EBde, PA, Cabatangan, Zamboanga City |
| 3. Submission of Bid Envelop | Date and Time: 10 July 2024 09:30 AM | Hqs, 54EBde, PA, Cabatangan, Zamboanga City |
| 4. Receipt and Opening of Bid Envelop (ROBE) | Date and Time: 10 July 2024 09:30 AM onwards | Hqs, 54EBde, PA, Cabatangan, Zamboanga City |

11. The tie-breaking method shall be non-discretionary and non-discriminatory. The same is based on sheer luck or chance (toss a coin) and in chronological order based on when the bidder passes their bidding documents.
12. The **Philippine Army** reserves the right to reject any and all bids, declare a failure of bidding, or not award the contract at any time prior to contract award in accordance with Sections 35.6 and 41 of the 2016 revised Implementing Rules and Regulations (IRR) of RA No. 9184, without thereby incurring any liability to the affected bidder or bidders.

13. For further information, please refer to:

LTC MICHAEL B DE GUIA (CE) PA
Head Secretariat
11ID SPECIAL BIDS AND AWARD COMMITTEE
115th Satellite Contracting Office, AFPPS,
Camp Gen Arturo Enrile, Malagutay, Zamboanga City
Email address: **115th11id@gmail.com**
Cp Nr: +639178168598

14. You may visit the following websites:

For downloading of Bidding Documents: **www.philgeps.gov.ph** or at **army.mil.ph**

Date of Issue: **19 June 2024**

BGEN ALEXEI C MUSÑGI PA
11ID SBAC Chairperson

Section II. Instructions to Bidders

1. Scope of Bid

The Procuring Entity, **Philippine Army** invite Bids for the **Construction of Chief of GSMO at 11ID, PA, Camp Bautista, Busbus, Jolo, Sulu** with Project Identification Number **11ID SBAC 010-24**.

The Procurement Project (referred to herein as “Project”) is for the construction of Works, as described in Section VI (Specifications).

2. Funding Information

2.1. The GOP through the source of funding as indicated below for **Calendar Year 2024** in the amount of **Four Million Nine Hundred Eighty-Eight Thousand Nine Hundred Thirteen Pesos (PhP4,988,913.00)**.

2.2. The source of funding is **General Appropriations Act for FY 2024**.

3. Bidding Requirements

The Bidding for the Project shall be governed by all the provisions of RA No. 9184 and its 2016 revised IRR, including its Generic Procurement Manual and associated policies, rules and regulations as the primary source thereof, while the herein clauses shall serve as the secondary source thereof.

Any amendments made to the IRR and other GPPB issuances shall be applicable only to the ongoing posting, advertisement, or invitation to bid by the BAC through the issuance of a supplemental or bid bulletin.

The Bidder, by the act of submitting its Bid, shall be deemed to have inspected the site, determined the general characteristics of the contracted Works and the conditions for this Project, such as the location and the nature of the work; (b) climatic conditions; (c) transportation facilities; (c) nature and condition of the terrain, geological conditions at the site communication facilities, requirements, location and availability of construction aggregates and other materials, labor, water, electric power and access roads; and (d) other factors that may affect the cost, duration and execution or implementation of the contract, project, or work and examine all instructions, forms, terms, and project requirements in the Bidding Documents.

4. Corrupt, Fraudulent, Collusive, Coercive, and Obstructive Practices

The Procuring Entity, as well as the Bidders and Contractors, shall observe the highest standard of ethics during the procurement and execution of the contract. They or through an agent shall not engage in corrupt, fraudulent, collusive, coercive, and obstructive practices defined under Annex “I” of the 2016 revised IRR of RA No. 9184 or other integrity violations in competing for the Project.

5. Eligible Bidders

- 5.1. Only Bids of Bidders found to be legally, technically, and financially capable will be evaluated.
- 5.2. The Bidder must have an experience of having completed a Single Largest Completed Contract (SLCC) that is similar to this Project, equivalent to at least fifty percent (50%) of the ABC adjusted, if necessary, by the Bidder to current prices using the PSA's CPI, except under conditions provided for in Section 23.4.2.4 of the 2016 revised IRR of RA No. 9184.

A contract is considered to be "similar" to the contract to be bid if it has the major categories of work stated in the **BDS**.
- 5.3. For Foreign-funded Procurement, the Procuring Entity and the foreign government/foreign or international financing institution may agree on another track record requirement, as specified in the Bidding Document prepared for this purpose.
- 5.4. The Bidders shall comply with the eligibility criteria under Section 23.4.2 of the 2016 IRR of RA No. 9184.

6. Origin of Associated Goods

There is no restriction on the origin of Goods other than those prohibited by a decision of the UN Security Council taken under Chapter VII of the Charter of the UN.

7. Subcontracts

- 7.1. The Bidder may subcontract portions of the Project to the extent allowed by the Procuring Entity as stated herein, but in no case more than fifty percent (50%) of the Project. However, the Procuring Entity has prescribed that **Subcontracting is not allowed**.

8. Pre-Bid Conference

The Procuring Entity will hold a pre-bid conference for this Project on the specified date and time and either at its physical address at **Hqs, 54EBde PA, Cabatangan, Zamboanga City**, as indicated in paragraph 6 of the **IB**.

9. Clarification and Amendment of Bidding Documents

Prospective bidders may request for clarification on and/or interpretation of any part of the Bidding Documents. Such requests must be in writing and received by the Procuring Entity, either at its given address or through electronic mail indicated in the **IB**, at least ten (10) calendar days before the deadline set for the submission and receipt of Bids.

10. Documents Comprising the Bid: Eligibility and Technical Components

- 10.1. The first envelope shall contain the eligibility and technical documents of the Bid as specified in **Section IX. Checklist of Technical and Financial Documents**.
- 10.2. If the eligibility requirements or statements, the bids, and all other documents for submission to the BAC are in foreign language other than English, it must be accompanied by a translation in English, which shall be authenticated by the appropriate Philippine foreign service establishment, post, or the equivalent office having jurisdiction over the foreign bidder's affairs in the Philippines. For Contracting Parties to the Apostille Convention, only the translated documents shall be authenticated through an apostille pursuant to GPPB Resolution No. 13-2019 dated 23 May 2019. The English translation shall govern, for purposes of interpretation of the bid.
- 10.3. A valid PCAB License is required, and in case of joint ventures, a valid special PCAB License, and registration for the type and cost of the contract for this Project. Any additional type of Contractor license or permit shall be indicated in the **BDS**.
- 10.4. A List of Contractor's key personnel (e.g., Project Manager, Project Engineers, Materials Engineers, and Foremen) assigned to the contract to be bid, with their complete qualification and experience data shall be provided. These key personnel must meet the required minimum years of experience set in the **BDS**.
- 10.5. A List of Contractor's major equipment units, which are owned, leased, and/or under purchase agreements, supported by proof of ownership, certification of availability of equipment from the equipment lessor/vendor for the duration of the project, as the case may be, must meet the minimum requirements for the contract set in the **BDS**.

11. Documents Comprising the Bid: Financial Component

- 11.1. The second bid envelope shall contain the financial documents for the Bid as specified in **Section IX. Checklist of Technical and Financial Documents**.
- 11.2. Any bid exceeding the ABC indicated in paragraph 1 of the **IB** shall not be accepted.
- 11.3. For Foreign-funded procurement, a ceiling may be applied to bid prices provided the conditions are met under Section 31.2 of the 2016 revised IRR of RA No. 9184.

12. Alternative Bids

Bidders shall submit offers that comply with the requirements of the Bidding Documents, including the basic technical design as indicated in the drawings and specifications. Unless there is a value engineering clause in the **BDS**, alternative Bids shall not be accepted.

13. Bid Prices

All bid prices for the given scope of work in the Project as awarded shall be considered as fixed prices, and therefore not subject to price escalation during contract implementation, except under extraordinary circumstances as determined by the NEDA and approved by the GPPB pursuant to the revised Guidelines for Contract Price Escalation guidelines.

14. Bid and Payment Currencies

14.1. Bid prices may be quoted in the local currency or trade able currency accepted by the BSP at the discretion of the Bidder. However, for purposes of bid evaluation, Bids denominated in foreign currencies shall be converted to Philippine currency based on the exchange rate as published in the BSP reference rate bulletin on the day of the bid opening.

14.2. Payment of the contract price shall be made in **Philippine Pesos**.

15. Bid Security

15.1. The Bidder shall submit a Bid Securing Declaration or any form of Bid Security in the amount indicated in the **BDS**, which shall be not less than the percentage of the ABC in accordance with the schedule in the **BDS**.

15.2. The Bid and bid security shall be valid until **120 calendar days from date of the Opening of Bids**. Any bid not accompanied by an acceptable bid security shall be rejected by the Procuring Entity as non-responsive.

16. Sealing and Marking of Bids

Each Bidder shall submit one copy of the first and second components of its Bid.

The Procuring Entity may request additional hard copies and/or electronic copies of the Bid. However, failure of the Bidders to comply with the said request shall not be a ground for disqualification.

If the Procuring Entity allows the submission of bids through online submission to the given website or any other electronic means, the Bidder shall submit an electronic copy of its Bid, which must be digitally signed. An electronic copy that cannot be opened or is corrupted shall be considered non-responsive and, thus, automatically disqualified.

17. Deadline for Submission of Bids

The Bidders shall submit on the specified date and time and either at its physical address or through online submission as indicated in paragraph 7 of the **IB**.

18. Opening and Preliminary Examination of Bids

18.1. The BAC shall open the Bids in public at the time, on the date, and at the place specified in paragraph 9 of the **IB**. The Bidders' representatives who are present shall sign a register evidencing their attendance. In case videoconferencing, webcasting or other similar technologies will be used, attendance of participants shall likewise be recorded by the BAC Secretariat.

In case the Bids cannot be opened as scheduled due to justifiable reasons, the rescheduling requirements under Section 29 of the 2016 revised IRR of RA No. 9184 shall prevail.

18.2. The preliminary examination of Bids shall be governed by Section 30 of the 2016 revised IRR of RA No. 9184.

19. Detailed Evaluation and Comparison of Bids

19.1. The Procuring Entity's BAC shall immediately conduct a detailed evaluation of all Bids rated "*passed*" using non-discretionary pass/fail criteria. The BAC shall consider the conditions in the evaluation of Bids under Section 32.2 of 2016 revised IRR of RA No. 9184.

19.2. If the Project allows partial bids, all Bids and combinations of Bids as indicated in the **BDS** shall be received by the same deadline and opened and evaluated simultaneously so as to determine the Bid or combination of Bids offering the lowest calculated cost to the Procuring Entity. Bid Security as required by **ITB** Clause 16 shall be submitted for each contract (lot) separately.

19.3. In all cases, the NFCC computation pursuant to Section 23.4.2.6 of the 2016 revised IRR of RA No. 9184 must be sufficient for the total of the ABCs for all the lots participated in by the prospective Bidder.

20. Post Qualification

Within a non-extendible period of five (5) calendar days from receipt by the Bidder of the notice from the BAC that it submitted the Lowest Calculated Bid, the Bidder shall submit its latest income and business tax returns filed and paid through the BIR Electronic Filing and Payment System (eFPS), and other appropriate licenses and permits required by law and stated in the **BDS**.

21. Signing of the Contract

The documents required in Section 37.2 of the 2016 revised IRR of RA No. 9184 shall form part of the Contract. Additional Contract documents are indicated in the **BDS**.

Section III. Bid Data Sheet

Bid Data Sheet

| ITB Clause | | | | | | | | | | | | | | | | | | | | | | | | | |
|--|---|--------------------|--------------------|--------------------|--|-------------------|-------------------|--------------------------------|-------------------|-------------------|----------------|-------------------|-------------------|------------------|-------------------|-------------------|-------------------------|-------------------|-------------------|----------------------|-------------------|-------------------|----------------|--------------|------------------|
| 3 | Non-compliance and/or non-conformance with the prescribed forms as provided in the Annexes of this bidding documents will be ground for disqualification. | | | | | | | | | | | | | | | | | | | | | | | | |
| 5.2 | For this purpose, contracts similar to the Project refer to contracts which have the same major categories of work, which shall be: Construction of Vertical/Horizontal Structure/Building. | | | | | | | | | | | | | | | | | | | | | | | | |
| 7.1 | No portion of the project/contract shall be subcontracted. | | | | | | | | | | | | | | | | | | | | | | | | |
| 10.3 | <p>Contractors must have valid and current Philippine Contractors Accreditation Board (PCAB) License with Classification / Category in General Engineering / General Building Classification/Category in General Building/General Engineering of C&D and Minimum Size Range of Small B (hereinafter referred to as the "WORKS"). The PCAB license must indicate "PCAB registered contractor for Government Projects."</p> <p>However, contractors under Small A and Small B categories without similar experience on the contract to be bid may be allowed to bid if the cost of such contract is not more than the Allowable Range of Contract Cost (ARCC) of their registration based on the guidelines as prescribed by the PCAB. Provided, Bidder submits a duly notarized Affidavit that it has no similar experience on the Contract.</p> | | | | | | | | | | | | | | | | | | | | | | | | |
| 10.4 | <p>The key personnel must meet the required minimum years of experience set below:</p> <table border="1" style="width: 100%; border-collapse: collapse; margin-top: 10px;"> <thead> <tr> <th style="width: 30%;">Key Personnel</th> <th style="width: 35%;">General Experience</th> <th style="width: 35%;">General Experience</th> </tr> </thead> <tbody> <tr> <td>Project In-Charge (Licensed Civil Engineer)</td> <td>Minimum (5) Years</td> <td>Minimum (3) Years</td> </tr> <tr> <td>Registered Electrical Engineer</td> <td>Minimum (5) Years</td> <td>Minimum (3) Years</td> </tr> <tr> <td>Master Plumber</td> <td>Minimum (5) Years</td> <td>Minimum (3) Years</td> </tr> <tr> <td>Safety Officer</td> <td>Minimum (5) Years</td> <td>Minimum (3) Years</td> </tr> <tr> <td>Materials Engineer</td> <td>Minimum (5) Years</td> <td>Minimum (3) Years</td> </tr> <tr> <td>Construction Foreman</td> <td>Minimum (5) Years</td> <td>Minimum (3) Years</td> </tr> </tbody> </table> | Key Personnel | General Experience | General Experience | Project In-Charge (Licensed Civil Engineer) | Minimum (5) Years | Minimum (3) Years | Registered Electrical Engineer | Minimum (5) Years | Minimum (3) Years | Master Plumber | Minimum (5) Years | Minimum (3) Years | Safety Officer | Minimum (5) Years | Minimum (3) Years | Materials Engineer | Minimum (5) Years | Minimum (3) Years | Construction Foreman | Minimum (5) Years | Minimum (3) Years | | | |
| Key Personnel | General Experience | General Experience | | | | | | | | | | | | | | | | | | | | | | | |
| Project In-Charge (Licensed Civil Engineer) | Minimum (5) Years | Minimum (3) Years | | | | | | | | | | | | | | | | | | | | | | | |
| Registered Electrical Engineer | Minimum (5) Years | Minimum (3) Years | | | | | | | | | | | | | | | | | | | | | | | |
| Master Plumber | Minimum (5) Years | Minimum (3) Years | | | | | | | | | | | | | | | | | | | | | | | |
| Safety Officer | Minimum (5) Years | Minimum (3) Years | | | | | | | | | | | | | | | | | | | | | | | |
| Materials Engineer | Minimum (5) Years | Minimum (3) Years | | | | | | | | | | | | | | | | | | | | | | | |
| Construction Foreman | Minimum (5) Years | Minimum (3) Years | | | | | | | | | | | | | | | | | | | | | | | |
| 10.5 | <p>The key personnel must meet the required minimum years of experience set below:</p> <p>(Description and technical specifications are provided under Section 6)</p> <table border="1" style="width: 100%; border-collapse: collapse; margin-top: 10px;"> <thead> <tr> <th style="width: 40%;">Equipment</th> <th style="width: 20%;">Capacity</th> <th style="width: 40%;">Number of Units</th> </tr> </thead> <tbody> <tr> <td colspan="3">Power tools:</td> </tr> <tr> <td>Welding Machine</td> <td>Min 500 Amp</td> <td>Min two (2) units</td> </tr> <tr> <td>Electric Drill</td> <td>Min 300 Watts</td> <td>Min two (2) units</td> </tr> <tr> <td>Electric Grinder</td> <td>Min 300 Watts</td> <td>Min two (2) units</td> </tr> <tr> <td>Generator Set (Standby)</td> <td>Min 50KVA</td> <td>Min two (2) units</td> </tr> <tr> <td colspan="3">Equipment:</td> </tr> <tr> <td>Concrete Mixer</td> <td>Min 1 bagger</td> <td>Min one (1) unit</td> </tr> </tbody> </table> | Equipment | Capacity | Number of Units | Power tools: | | | Welding Machine | Min 500 Amp | Min two (2) units | Electric Drill | Min 300 Watts | Min two (2) units | Electric Grinder | Min 300 Watts | Min two (2) units | Generator Set (Standby) | Min 50KVA | Min two (2) units | Equipment: | | | Concrete Mixer | Min 1 bagger | Min one (1) unit |
| Equipment | Capacity | Number of Units | | | | | | | | | | | | | | | | | | | | | | | |
| Power tools: | | | | | | | | | | | | | | | | | | | | | | | | | |
| Welding Machine | Min 500 Amp | Min two (2) units | | | | | | | | | | | | | | | | | | | | | | | |
| Electric Drill | Min 300 Watts | Min two (2) units | | | | | | | | | | | | | | | | | | | | | | | |
| Electric Grinder | Min 300 Watts | Min two (2) units | | | | | | | | | | | | | | | | | | | | | | | |
| Generator Set (Standby) | Min 50KVA | Min two (2) units | | | | | | | | | | | | | | | | | | | | | | | |
| Equipment: | | | | | | | | | | | | | | | | | | | | | | | | | |
| Concrete Mixer | Min 1 bagger | Min one (1) unit | | | | | | | | | | | | | | | | | | | | | | | |

| | | | |
|------|--|----------------|-------------------|
| | Dump Truck | Min 3 cum | Min two (2) units |
| | Bulldozer | Min 500 sqm/hr | Min one (1) unit |
| | Grader | Min 50 cum/hr | Min one (1) unit |
| | Road Roller | Min 50 cum/hr | Min one (1) unit |
| | Water Truck | Min 16,000 ltr | Min one (1) unit |
| 12 | Value Engineering is not allowed. | | |
| 15.1 | <p>The bid security shall be in the form of a Bid Securing Declaration or any of the following forms and amounts for each line items:</p> <p>a. The amount of not less than Php99,778.26 (2% of ABC) if bid security is in cash, cashier's/manager's check, bank draft/guarantee or irrevocable letter of credit;</p> <p>b. The amount of not less than Php249,445.65 (5% of ABC) if bid security is in Surety Bond</p> | | |
| 16 | <p>Each Bidder shall submit One (1) original copy and two (2) photo copies of the first and second components of its bid.</p> <p>Note: Unsealed and unsigned bid envelop and failure to submit the required original copy shall be a ground for disqualification.</p> | | |
| 19.2 | <p>Partial bid is not allowed. The Infra project is packed in a single lot and the lot shall not be divided into sub-lots for the purpose of bidding evaluation and contract award.</p> | | |
| 20 | <p>POST QUALIFICATION:</p> <p>Within a non-extendible period of Five (5) Calendar Days from receipt by the supplier of the Notice from the PABAC3 that the supplier has the Single/Lowest Calculated Bid (S/LCB), the Supplier shall submit the following requirements for post qualification:</p> <p>1. Present the original copy and submit copy of the following:</p> <p>a) Latest Income Tax Returns per Revenue Regulations 3-2005; Tax returns filed through the Electronic Filing and Payments System (EFPS). The latest income and business tax returns are those within the last six months preceding the date of bid submission (including copy of VAT returns and corresponding payments for the last 6 months).</p> <p>b) Valid and Current PHILGEPS Certificate of Registration (Platinum Membership) annexes.</p> <p>c) Valid and Current SSS Clearance or Latest Quarter Premium Remittances and Valid and Current DOLE Clearance OR an Undertaking to present original and submit Copy of a valid and current SSS Clearance or Latest Quarter Premium Remittances and valid and current DOLE Clearance if declared as the Lowest or Single Calculated and Responsive Bid (L/SCB);</p> <p>d) PO's or Contract for all Ongoing Contract</p> <p>e) PO or Contract for Single Largest Contract</p> <p>f) Certificate of Notarial Commission/ Oath of Office/Appointment of the lawyer who notarized the documents submitted by the bidder or Certificate from the Office of the Executive Judge/Office of the Clerk of Court certifying the notary public is appointed/commissioned for a specific period.</p> | | |

| | |
|-----------|---|
| | <p>g) Registration certificate from the Securities and Exchange Commission (SEC) for corporations, Department of Trade and Industry (DTI) for sole proprietorship, or Cooperative Development Authority (CDA) for cooperatives.</p> <p>h) Valid and current Philippine Contractors Accreditation Board (PCAB) license with Classification/Category in General Building/General Engineering of C&D and Minimum Size Range of Small B (hereinafter referred to as the “WORKS”). The PCAB license must indicate “PCAB registered contractor for Government Projects.”</p> <p>i) Valid and Current Business/Mayor’s Permit issued by the city or municipality where the principal place of business of the prospective bidder is located OR the equivalent document for Exclusive Economic Zones or Areas; In case of recently expired Mayor’s/Business permits, said permit shall be submitted together with the official receipt as proof that the bidder has applied for renewal within the period prescribed by the concerned local government unit, provided that the renewed permit shall be submitted as a post-qualification requirement.</p> <p>j) Valid and current Tax Clearance per Executive Order 398, Series of 2005, as finally reviewed and approved by BIR, issued by the Accounts Receivable Monitoring Division of BIR.</p> <p>k) Copy of the following Audited Financial Statements for 2022 and 2021 (in comparative form or separate reports) with attached:</p> <ul style="list-style-type: none"> (a) Independent Auditor’s Report; (b) Balance Sheet (Statement of Financial Position); and (c) Income Statement (Statement of Comprehensive Income) Each of the above statements must have stamped “received” by the Bureau of Internal Revenue (BIR) or its duly accredited and authorized institutions. <p>l) Constructor’s Performance Evaluation System (CPES) Final Rating which must be Satisfactory; or Owner’s Certificate of Acceptance; or Completion for Single Largest Completed Contract.</p> <p>m) Certificate from the Armed Forces of the Philippines Procurement Service.</p> <p>2. Submit the original copy of the following:</p> <ul style="list-style-type: none"> a) Company Profile or Company Brochure. Company printed brochure may be included. b) Vicinity map/location of the business. <p>(In case of Joint Venture, partners must present/ submit above document.)</p> <p>Failure to submit any of the post-qualification requirement on time, or a finding against the veracity thereof, shall disqualify the bidder for award. Should there be a finding against the veracity of any of the document submitted, the Bid Security shall be forfeited in accordance with Sec. 69 of the IRR of RA 9184.</p> <p>As part of the Post Qualification, eligibility and technical document submitted by the SCB/LCB, will be validated and verified.</p> |
| <p>21</p> | <p>Additional contract documents relevant to the Project that may be required by existing laws and/or the Procuring Entity to be submitted during Post-Qualification to include:</p> |

| | |
|--|--|
| | <ul style="list-style-type: none">a) Construction Methodsb) Construction Schedule (PERT/CPM and Gantt Chart and S-Curve)c) Manpower Schedule (Gantt Chart)d) Equipment Utilization Schedule (Gantt Chart) Construction Safety and Health Program |
|--|--|

Section IV. General Conditions of Contract

1. Scope of Contract

This Contract shall include all such items, although not specifically mentioned, that can be reasonably inferred as being required for its completion as if such items were expressly mentioned herein. All the provisions of RA No. 9184 and its 2016 revised IRR, including the Generic Procurement Manual, and associated issuances, constitute the primary source for the terms and conditions of the Contract, and thus, applicable in contract implementation. Herein clauses shall serve as the secondary source for the terms and conditions of the Contract.

This is without prejudice to Sections 74.1 and 74.2 of the 2016 revised IRR of RA No. 9184 allowing the GPPB to amend the IRR, which shall be applied to all procurement activities, the advertisement, posting, or invitation of which were issued after the Effectivity of the said amendment.

2. Sectional Completion of Works

If sectional completion is specified in the **Special Conditions of Contract (SCC)**, references in the Conditions of Contract to the Works, the Completion Date, and the Intended Completion Date shall apply to any Section of the Works (other than references to the Completion Date and Intended Completion Date for the whole of the Works).

3. Possession of Site

4.1. The Procuring Entity shall give possession of all or parts of the Site to the Contractor based on the schedule of delivery indicated in the **SCC**, which corresponds to the execution of the Works. If the Contractor suffers delay or incurs cost from failure on the part of the Procuring Entity to give possession in accordance with the terms of this clause, the Procuring Entity's Representative shall give the Contractor a Contract Time Extension and certify such sum as fair to cover the cost incurred, which sum shall be paid by Procuring Entity.

4.2. If possession of a portion is not given by the above date, the Procuring Entity will be deemed to have delayed the start of the relevant activities. The resulting adjustments in contract time to address such delay may be addressed through contract extension provided under Annex "E" of the 2016 revised IRR of RA No. 9184.

4. The Contractor's Obligations

The Contractor shall employ the key personnel named in the Schedule of Key Personnel indicating their designation, in accordance with **ITB** Clause 10.3 and specified in the **BDS**, to carry out the supervision of the Works.

The Procuring Entity will approve any proposed replacement of key personnel only if their relevant qualifications and abilities are equal to or better than those of the personnel listed in the Schedule.

5. Performance Security

- 5.1. Within ten (10) calendar days from receipt of the Notice of Award from the Procuring Entity but in no case later than the signing of the contract by both parties, the successful Bidder shall furnish the performance security in any of the forms prescribed in Section 39 of the 2016 revised IRR.
- 5.2. The Contractor, by entering into the Contract with the Procuring Entity, acknowledges the right of the Procuring Entity to institute action pursuant to RA No. 3688 against any subcontractor be they an individual, firm, partnership, corporation, or association supplying the Contractor with labor, materials and/or equipment for the performance of this Contract.

6. Site Investigation Reports

The Contractor, in preparing the Bid, shall rely on any Site Investigation Reports referred to in the **SCC** supplemented by any information obtained by the Contractor.

7. Warranty

- 7.1. In case the Contractor fails to undertake the repair works under Section 62.2.2 of the 2016 revised IRR, the Procuring Entity shall forfeit its performance security, subject its property(ies) to attachment or garnishment proceedings, and perpetually disqualify it from participating in any public bidding. All payables of the GOP in his favor shall be offset to recover the costs.
- 7.2. The warranty against Structural Defects/Failures, except that occasioned-on force majeure, shall cover the period from the date of issuance of the Certificate of Final Acceptance by the Procuring Entity. Specific duration of the warranty is found in the **SCC**.

8. Liability of the Contractor

Subject to additional provisions, if any, set forth in the **SCC**, the Contractor's liability under this Contract shall be as provided by the laws of the Republic of the Philippines.

If the Contractor is a joint venture, all partners to the joint venture shall be jointly and severally liable to the Procuring Entity.

9. Termination for Other Causes

Contract termination shall be initiated in case it is determined *prima facie* by the Procuring Entity that the Contractor has engaged, before, or during the implementation of the contract, in unlawful deeds and behaviors relative to contract acquisition and implementation, such as, but not limited to corrupt, fraudulent, collusive, coercive, and obstructive practices as stated in **ITB** Clause 4.

10. Dayworks

Subject to the guidelines on Variation Order in Annex “E” of the 2016 revised IRR of RA No. 9184, and if applicable as indicated in the **SCC**, the Day works rates in the Contractor’s Bid shall be used for small additional amounts of work only when the Procuring Entity’s Representative has given written instructions in advance for additional work to be paid for in that way.

11. Program of Work

11.1. The Contractor shall submit to the Procuring Entity’s Representative for approval the said Program of Work showing the general methods, arrangements, order, and timing for all the activities in the Works. The submissions of the Program of Work are indicated in the **SCC**.

11.2. The Contractor shall submit to the Procuring Entity’s Representative for approval an updated Program of Work at intervals no longer than the period stated in the **SCC**. If the Contractor does not submit an updated Program of Work within this period, the Procuring Entity’s Representative may withhold the amount stated in the **SCC** from the next payment certificate and continue to withhold this amount until the next payment after the date on which the overdue Program of Work has been submitted.

12. Instructions, Inspections and Audits

The Contractor shall permit the GOP or the Procuring Entity to inspect the Contractor’s accounts and records relating to the performance of the Contractor and to have them audited by auditors of the GOP or the Procuring Entity, as may be required.

13. Advance Payment

The Procuring Entity shall, upon a written request of the Contractor which shall be submitted as a Contract document, make an advance payment to the Contractor in an amount not exceeding fifteen percent (15%) of the total contract price, to be made in lump sum, or at the most two installments according to a schedule specified in the **SCC**, subject to the requirements in Annex “E” of the 2016 revised IRR of RA No. 9184.

14. Progress Payments

The Contractor may submit a request for payment for Work accomplished. Such requests for payment shall be verified and certified by the Procuring Entity’s Representative/Project Engineer. Except as otherwise stipulated in the **SCC**, materials and equipment delivered on the site but not completely put in place shall not be included for payment.

15. Operating and Maintenance Manuals

- 15.1. If required, the Contractor will provide “as built” Drawings and/or operating and maintenance manuals as specified in the **SCC**.
- 15.2. If the Contractor does not provide the Drawings and/or manuals by the dates stated above, or they do not receive the Procuring Entity’s Representative’s approval, the Procuring Entity’s Representative may withhold the amount stated in the **SCC** from payments due to the Contractor.

Section V. Special Conditions of Contract

Special Conditions of Contract

| GCC Clause | | |
|------------|--|---|
| 2 | Project | Project Duration (No. of Calendar days) |
| | Construction of GSMO Quarters at 11ID, PA, Camp Bautista, Busbus, Jolo, Sulu | One Hundred Twenty (120) Calendar days upon receipt of Notice to Proceed or Notice of Site Possession whichever comes later |
| 4.1 | The Start Date of construction is within Seven (7) Calendar Days upon receipt of the Notice to Proceed (NTP) together with the Notice of Site Possession by the winning bidder provided that Notice of Site Possession is issued within the same period. Notice of Site Possession will be issued by Commanding Officer, 11IMB, IMCOM, PA. | |
| 6 | Site Investigation Reports are not applicable. | |
| 7.2 | The warranty against Structural Defects/Failures, except those occasioned on force majeure, shall cover the period of Fifteen (15) Years reckoned from the date of issuance of the Certificate of Final Acceptance by the Procuring Entity. | |
| 10 | Day works are applicable at the rate shown in the Contractor's original Bid. | |
| 11.1 | The Contractor shall submit the Program of Works and Project Management Tools to the Procuring Entity's Representative within seven (7) calendar days from receipt of the Notice of Award. | |
| 11.2 | The amount to be withheld for late submission of an updated Program of Work is one percent (1%) of the progress billing. | |
| 13 | <p>The amount of the advance payment is 15% of the Contract Price which shall be given to the contractor not later than 15 calendar days from receipt by the Procuring Entity of the contractor's request and the submission by the contractor of an irrevocable standby letter of credit of equivalent value from a commercial bank, a bank guarantee or a surety bond callable on demand, issued by a surety or insurance company duly licensed by the Insurance Commission and confirmed by the Procuring Entity together with duly received Notice of Site Possession.</p> <p>The letter request for release of 15% advance payment shall also be accompanied with a list of construction materials to be procured using the advance payment.</p> | |
| 14 | <p>The terms of payment shall be progress payment in two (2) installments.</p> <p>1st payment is upon reaching physical accomplishment of 30% of contract amount less 5% of the advance payment and 5% for the retention money, and 2nd payment is upon reaching physical accomplishment of 60% of contract amount less 5% of the advance payment and 5% for the retention money and the final payment is upon reaching physical accomplishment of 100% less 10% of the advance payment and 5% for the retention money.</p> | |

| | Payment | Amount |
|------|---|--|
| | Advance payment | 15% of the contract amount |
| | 1 st payment | 30% of the contract amount less 5% of the advance payment and 5% for the retention money |
| | 2 nd payment | 60% of the contract amount less 10% of the advance payment and 5% for the retention money |
| | Final payment | 100% of the contract amount less 10% of the advance payment and 5% for the retention money <i>(after the conduct and final approval of Technical Inspection and Acceptance Committee [TIAC])</i> |
| | <i>Note: Every payment must be accompanied by Statement of Work Accomplishment (SWA) signed by the Project Administrator (PRAD).</i> | |
| 15.1 | The operating and maintenance manuals and “as built” drawings are required during the conduct of Technical Inspection and Acceptance Committee (TIAC). | |
| 15.2 | The amount to be withheld for failing to produce “as built” drawings and/or operating and maintenance manuals by the date required is the amount in the final payment. | |

Section VI. Specifications

Technical Specifications

**Construction of GSMO Quarters at 11ID, PA,
Camp Bautista, Busbus, Jolo, Sulu
Bid Ref. No. 11ID SBAC 012-24
Approved Budget Contract: PhP4,988,913.00**

ARMY 2040: WORLD CLASS. MULTI-MISSION READY. CROSS-DOMAIN CAPABLE.

HEADQUARTERS
PHILIPPINE ARMY
OFFICE OF THE ARMY CHIEF ENGINEER
Fort Andres Bonifacio, Metro Manila

Materials Specifications for Vertical/Horizontal Structure Projects

| Scope of Works/Work Items | Specifications |
|--------------------------------|---|
| EARTHWORKS | |
| Item 104 - Embankment/Backfill | Backfill materials shall be composed of suitable materials. It shall be placed in layers not exceeding 200mm in loose thickness and each layer should be thoroughly compacted as specified before the next layer is placed. It must conform with the provisions of Item104 of the DPWH Standard Specifications Volume II. |
| Concrete Works | |
| Item 204 – Structural Concrete | Must have a minimum compressive strength of 3000 psi for structural and non-structural members such footing, beams, columns, suspended slab and slab on grade. It must also conforms with the provisions for Item 900 (page 8-15) of the of the DPWH Standard Specifications Volume III. |
| Cement | It shall conform to all the requirements of subsection 311.2.1 of Item 311 of DPWH Standard Specifications Vol II |
| Sand | It shall conform to the requirements of subsection 311.2.2 of Item 311 of the DPWH Standard Volume II |
| Gravel | It shall conform to the requirements of subsection 311.2.2 of the DPWH Standard Specifications Volume II except that gradation shall conform to Table 405.1. Use class “A” grading requirement. |
| Reinforcing Steel | Use deformed bars with yield strength as specified on plan and conforms with Item 900.2.4 of DPWH Standard Specifications for Public Works Structure Vol III and Philippine National Standard (PNS 49:2002). |
| Steel Works | |
| Angle Bars | Use angle bars that conforms with the provision of Philippine National Standard (PNS 657:2008) |
| Tubular Steel Pipes | It must conforms with the provision of Philippine National Standard (PNS 26:2003) |
| Masonry Works | |
| Concrete Hollow Blocks | Use CHB that conforms with subsection 704.3 of Item 704 of DPWH Standard Specifications Vol II. |
| Plastering | Plastering for all wall surfaces of CHB including the structural members shall be with minimum of thickness of 16mm. It must be in compliant to Item 1027 of the DPWH Standard Specifications Volume III. |
| Steel Reinforcement | All Masonry walls shall be reinforced with deformed bars according to the approved plans. |
| Carpentry Works | |

| |
|---|
| CONFORME: _____ Name of Company (in print) _____ Name and Signature of Company Authorized Representative _____ Date |
|---|



Technical Specifications

**Construction of GSMO Quarters at 11ID, PA,
Camp Bautista, Busbus, Jolo, Sulu
Bid Ref. No. 11ID SBAC 012-24
Approved Budget Contract: PhP4,988,913.00**

ARMY 2040: WORLD CLASS. MULTI-MISSION READY. CROSS-DOMAIN CAPABLE.

| | |
|--|---|
| Lumber | All lumber to be used shall be kiln dry and free from all kinds of defects that may impair their strength or durability as required under subsection 1003.2.1 of DPWH Standard Specifications for Public Works Structures Vol III. |
| Plywood | Must conform to the provision stipulated under subsection 1003.2.3 of Item 1003 of the DPWH Standard Specifications for Public Works Structure Volume III, |
| Doors and Windows | Use Panel Door and jamb that conforms with the specifications under Item 1010 of the DPWH Standard Specifications Volume III. Aluminum Glass Door must conform with the provision of Item 1007 of the DPWH Standard Specifications Volume III. |
| Door Knobs | Unless otherwise specified, door locksets must be consistent with the provisions of Item 1004.2.1.1 of the DPWH Standard Specifications Volume III. |
| Plumbing Works | |
| Sanitary and water supply pipes and fittings | Pipes & fittings for water supply must conform to the provision under subsection 1002.2.3 of Item 1002 of the DPWH Standard Specifications for Public Works Structures Volume III. |
| Plumbing Fixtures and Fittings | Must be compliant with the provisions under subsection 1002.2.5 of Item 1002 of the DPWH Standard Specifications Volume III |
| Electrical Works | |
| Wires and Wiring Devices | Shall be of the approved type meeting all the requirements of the Philippine Electrical Code and Philippine National Standard (PNS 35-1:2013) bearing Philippine Standard Agency (PSA) mark as required under subsection 1101.1 of Item 1101 of DPWH Standard Specifications. |
| Conduit, Boxes & Fittings | Must be compliant with the requirements and provisions stipulated under Item 1100 of the DPWH Standard Specifications Volume III. |
| Lighting Fixtures | Use DPWH approved and compliant to the Philippine National Standards (PNS IEC 60968:2012 or PNS 62560:2012) bearing PSA mark. |
| Panel Board | Must be compliant with the requirements and provisions stipulated under Item 1102 of the DPWH Standard Specifications Volume III. |
| Circuit Breakers | Shall be thermal magnetic type with quick make, quick break trip free operating mechanism, bolt-on type and shall be molded case complying with NEMA and Philippine National Standard (PNS 519:1991) bearing PSA mark/Stickers. |
| Hardware | |
| Rough Hardware | All rough hardware such as nails, screws, lag screws, bolts, and other related fasteners required for carpentry works shall first class quality and locally available as required under subsection 1004.2.1 of DPWH Standard Specifications for Public Structure Vol III. |

CONFORME:

Name of Company (in print)

Name and Signature of Company Authorized Representative

Date



HONOR. PATRIOTISM. DUTY.



Technical Specifications

**Construction of GSMO Quarters at 11ID, PA,
Camp Bautista, Busbus, Jolo, Sulu
Bid Ref. No. 11ID SBAC 012-24
Approved Budget Contract: PhP4,988,913.00**

ARMY 2040: WORLD CLASS. MULTI-MISSION READY. CROSS-DOMAIN CAPABLE.

| | |
|---|---|
| Finishing Hardware | All finishing hardware consisting of lockset, latches, bolts, and other rough hardware such as nails, screws, lag screws, bolts, and other related fasteners required for carpentry works shall first class quality and locally available as required under subsection 1004.2.1 of DPWH Standard Specifications for Public Structure Vol III. |
| Finishing Works | |
| Tiles | Use premium grade ceramics floor and wall tiles that conforms to the specification of Item 1018 of the DPWH Standard Specifications Volume III. |
| Roofing | Must conform with the provisions of Item 1014 of the DPWH Standard Specifications Volume III. |
| Painting | Must be compliant with the requirements and provisions stipulated under Item 1032 (Painting, Varnishing and other Related Works of the DPWH Standard Specifications Volume III. Use the following types: 1. Masonry wall surfaces: a. Interior wall surfaces – used latex paints for interior surfaces b. Exterior wall surfaces – used latex paint for exterior surfaces 2. Wood surfaces – enamel paint 3. Steel Surfaces – use metal paints |
| Others | All other works and items must be compliant with the requirements and provisions of the DPWH Standard Specifications |
| <p>Note: To better ensure proper quality control, all materials shall be subject to random testing at any DPWH Accredited Testing Center as required and as chosen by the Project Administrator. Such tests are (If applicable but not limited to):</p> <ol style="list-style-type: none"> 1) Quality Test for Gravel and sand 2) Tensile Test for Reinforcing Bars 3) Quality Test of Aggregates (Subbase and Base Course) 4) Quality test of Portland cement 5) Other applicable test needed as required by the Project Administrator. <p>During the actual testing, the Contractor/Representative and the Project Administrator/Representative must be present to witness the test. Cost for the Testing and other related activities hereto must be shouldered by the supplier.</p> | |

| |
|---|
| CONFORME: |
| _____ |
| Name of Company (in print) |
| _____ |
| Name and Signature of Company Authorized Representative |
| _____ |
| Date |



HONOR. PATRIOTISM. DUTY.



Technical Specifications

Construction of GSMO Quarters at 11ID, PA,
Camp Bautista, Busbus, Jolo, Sulu
Bid Ref. No. 11ID SBAC 012-24
Approved Budget Contract: PhP4,988,913.00

ARMY 2040: WORLD CLASS. MULTI-MISSION READY. CROSS-DOMAIN CAPABLE.

This is to certify that the Construction Specifications of each Scope of Works/Work Items stated above was taken from the DPWH Standard Specifications Volume II and III and Philippine National Standard.

Certified by:

Noted by:

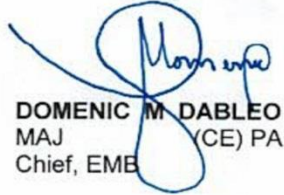
DOMENIC M DABLEO
MAJ (CE) PA
Chief, EMB

JOSE EDUARDO F LIBOON
Colonel GSC (CE) PA
Army Chief Engineer

| |
|---|
| CONFORME: |
| _____ |
| Name of Company (in print) |
| _____ |
| Name and Signature of Company Authorized Representative |
| _____ |
| Date |



HONOR. PATRIOTISM. DUTY.



Section VII. Drawings

**Construction of GSMO Quarters at 11ID, PA,
Camp Bautista, Busbus, Jolo, Sulu
Bid Ref. No. 11ID SBAC 012-24
Approved Budget Contract: PhP4,988,913.00**

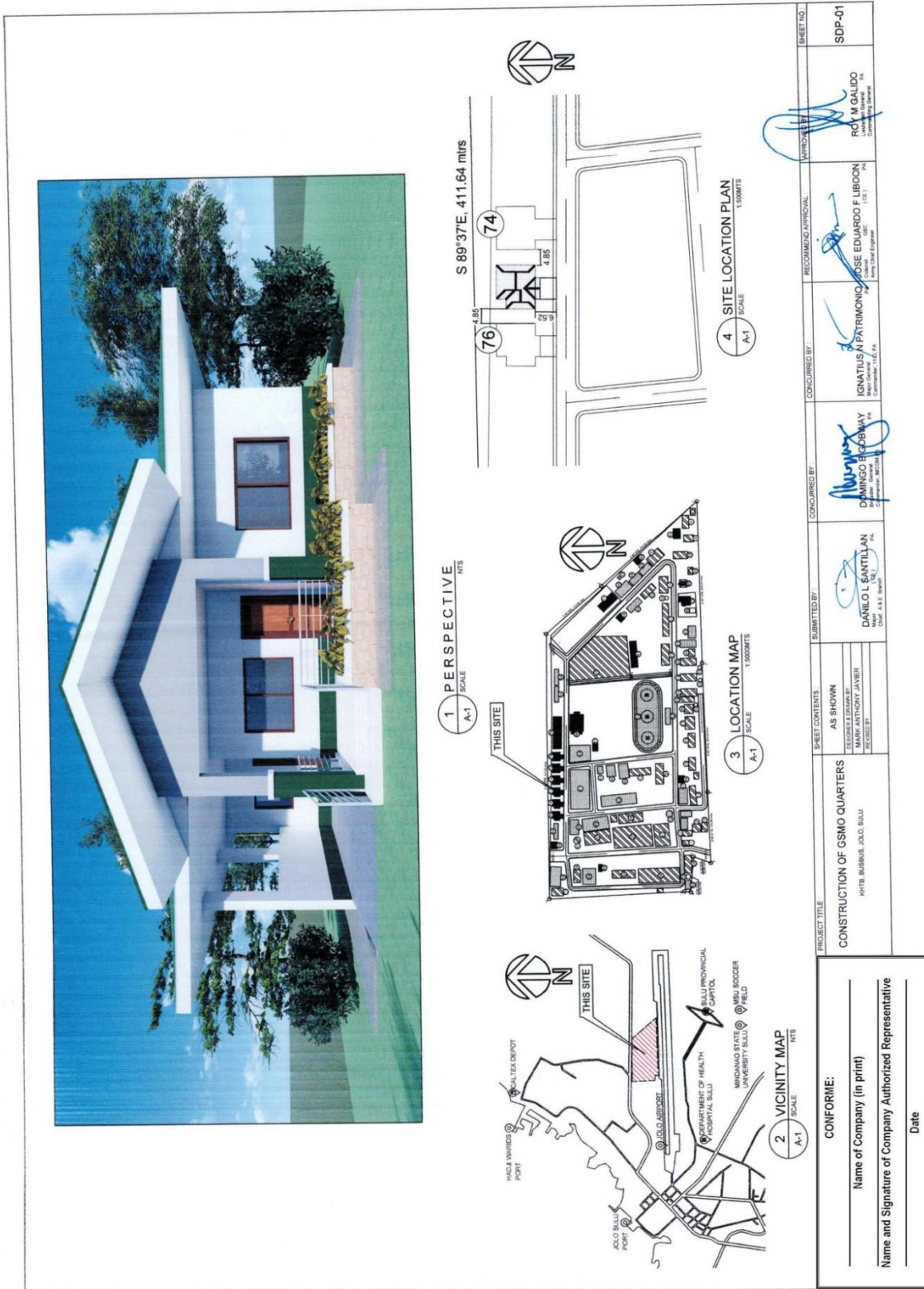

**Construction of GSMO Quarters at 11ID, PA,
Camp Bautista, Busbus, Jolo, Sulu
Bid Ref. No. 11ID SBAC 012-24
Approved Budget Contract: PhP4,988,913.00**

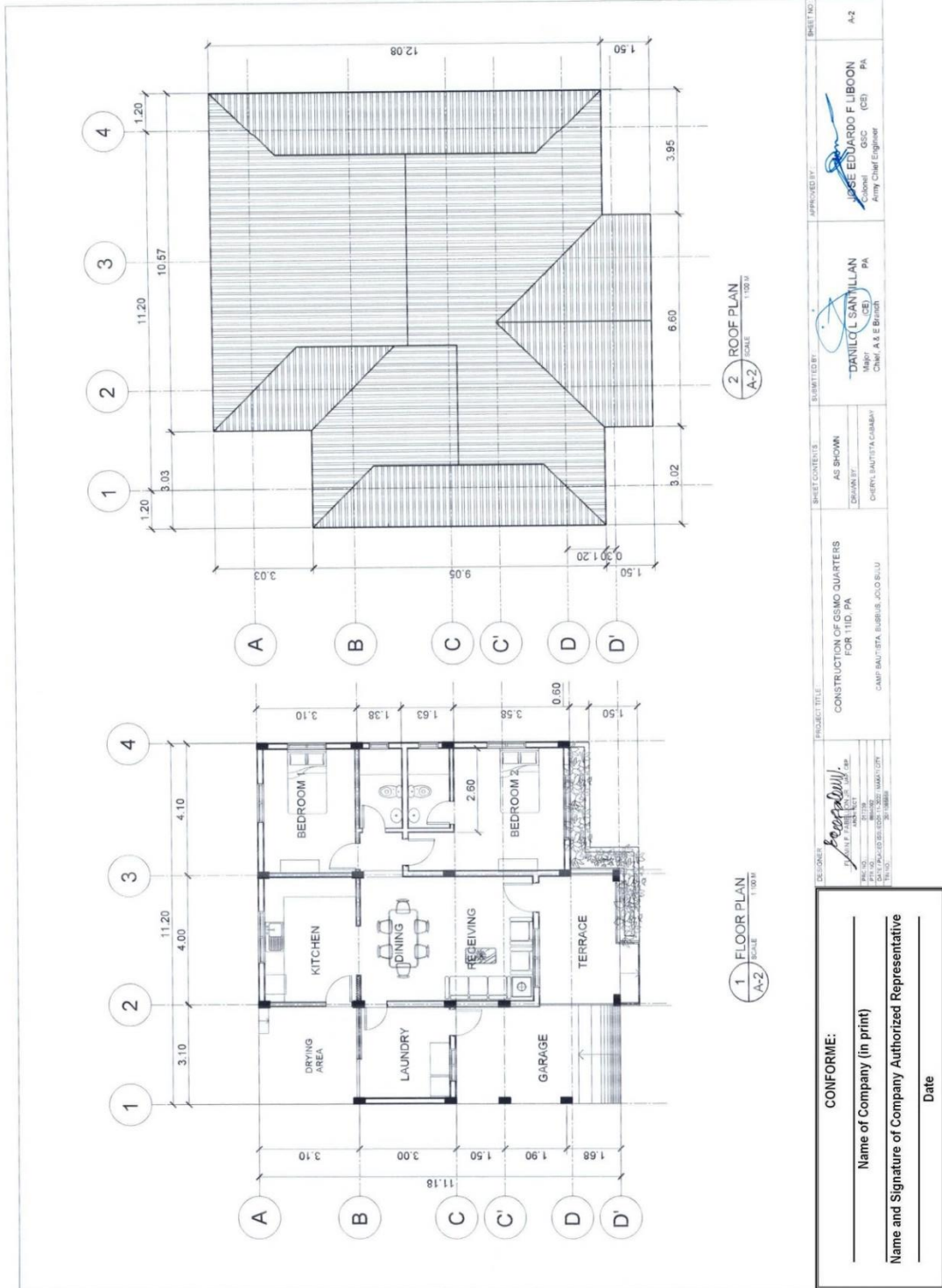

**Construction of GSMO Quarters at 11ID, PA,
Camp Bautista, Busbus, Jolo, Sulu
Bid Ref. No. 11ID SBAC 012-24
Approved Budget Contract: PhP4,988,913.00**

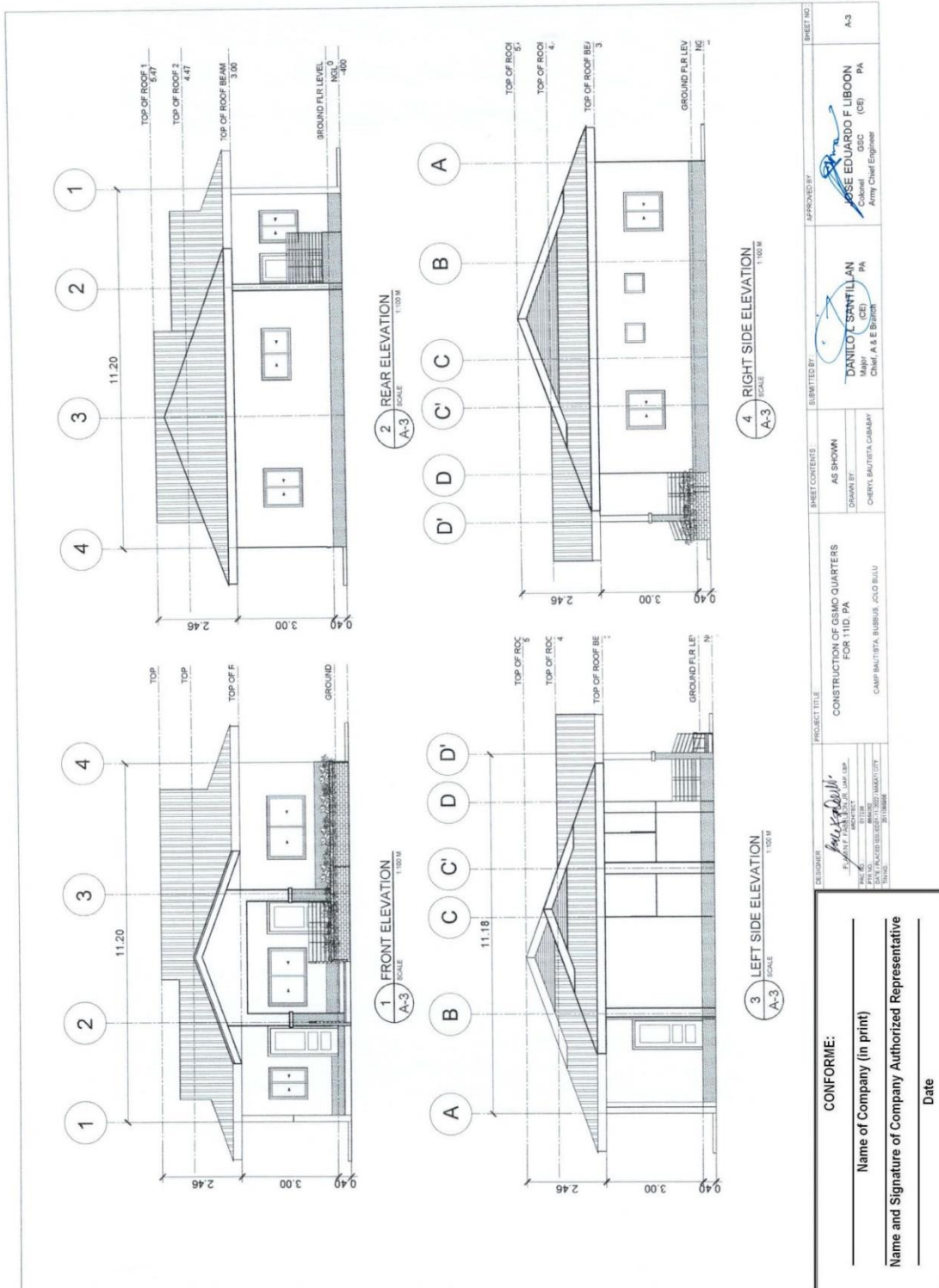

| | | | | | | |
|--|--|---|---|--|---|--------------------------|
| <p>CONFORME:</p> <p>_____ Name of Company (in print)</p> <p>_____ Name and Signature of Company Authorized Representative</p> <p>_____ Date</p> | | <p>DESIGNER: <i>[Signature]</i> F. R. ALY, ARCHITECT, INC. (P.A.) NO. 101-101-101-101 101-101-101-101 101-101-101-101</p> | <p>PROJECT TITLE: CONSTRUCTION OF GSMO QUARTERS FOR 11ID, PA CAMP BAUTISTA, BUSBUS, JOLO SULU</p> | <p>SHEET CONTENTS: AS SHOWN DRAWN BY: CHERYL BAUTISTA GOSMAY</p> | <p>APPROVED BY: <i>[Signature]</i> ROSE EDUARDO F. LIBOON Colonel GSC (CE) PA Army Chief Engineer</p> | <p>SHEET NO: A-3</p> |
|--|--|---|---|--|---|--------------------------|

**Construction of GSMO Quarters at 11ID, PA,
Camp Bautista, Busbus, Jolo, Sulu
Bid Ref. No. 11ID SBAC 012-24
Approved Budget Contract: PhP4,988,913.00**

| | | | |
|---|--|--|---|
| <p>SLIDING WINDOW ANALOG FRAME WITH 6MM OR 1/4" THK CLEAR GLASS 1.80 0.90 2.10 0.60 1 UNIT</p> | <p>SLIDING WINDOW ANALOG FRAME WITH 6MM OR 1/4" THK CLEAR GLASS 1.20 0.90 2.10 0.60 1 UNIT</p> | <p>SLIDING WINDOW ANALOG FRAME WITH 6MM OR 1/4" THK CLEAR GLASS 1.00 0.90 2.10 0.50 1 UNIT</p> | <p>AWNING WINDOW ANALOG FRAME WITH 6MM OR 1/4" THK CLEAR GLASS 0.60 1.50 2.10 0.60 2 UNIT</p> |
| <p>SOLID PANEL DOOR WITH DESIGN, LOCKSET AND 3 LOSE PIN PER LEAF, WOOD JAMB 1.00 2.10 1 UNIT</p> | <p>SOLID PANEL DOOR WITH DESIGN, LOCKSET AND 3 LOSE PIN PER LEAF, WOOD JAMB 0.90 2.10 1 UNIT</p> | <p>SOLID PANEL DOOR WITH DESIGN, LOCKSET AND 3 LOSE PIN PER LEAF, WOOD JAMB 0.90 2.10 2 UNIT</p> | <p>SOLID PANEL DOOR WITH DESIGN, LOCKSET AND 3 LOSE PIN PER LEAF, WOOD JAMB 0.90 2.10 2 UNIT</p> |
| <p>PVC DOOR WITH LOWER BELOW, CYLINDRICAL LOCKSET AND 3 LOSE PIN PER LEAF, WOOD JAMB 0.70 2.10 2 UNIT</p> | <p>1 SCHEDULE OF DOORS AND WINDOWS SCALE A-5 1:5 METERS</p> | | |

| | | | | | |
|---|--|---|---|--|------------------|
| DESIGNER J. LIBOON 137020 DATE: 11/04/2013 TIME: 10:44 AM | PROJECT TITLE CONSTRUCTION OF GSMO QUARTERS FOR 11ID, PA CAMP BAUTISTA, BUSBUS, JOLO SULO | SHEET CONTENTS AS SHOWN DRAWN BY: DMJ | SUBMITTED BY: DAMILO L. SANTIILAN Major (CE) Chief, A & E Branch | APPROVED BY: JOSE EDUARDO F. LIBOON GSC Colonel (CE) Army Chief Engineer | SHEET NO. A-5 |
|---|--|---|---|--|------------------|

CONFORME:

Name of Company (In print) _____

Name and Signature of Company Authorized Representative _____

Date _____

**Construction of GSMO Quarters at 11ID, PA,
Camp Bautista, Busbus, Jolo, Sulu
Bid Ref. No. 11ID SBAC 012-24
Approved Budget Contract: PhP4,988,913.00**

RIGHT SIDE VIEW

LEFT SIDE VIEW

DETAIL A

BLDV. UP. DETAIL

LOUVER

| Nº | a (M) | b (M) | c (M) | H (M) |
|----|-------|-------|-------|-------|
| 1 | 5.40 | 2.70 | 1.20 | 1.00 |
| 2 | 2.60 | 1.25 | - | 0.45 |
| 3 | 2.30 | 1.70 | - | 0.60 |

1 ROOF VENT LOUVER
SCALE 1:50 METERS

CONFORME:

Name of Company (in print)

Name and Signature of Company Authorized Representative

Date

PROJECT TITLE: CONSTRUCTION OF GSMO QUARTERS FOR 11ID, PA
CAMP BAUTISTA, BUSBUS, JOLO SULU

DESIGNER: *Genesys Bulk*

CLIENT: GSMA

DATE: 14/02/2024

SCALE: 1:50 METERS

PROJECT NO.: 11ID-SBAC-012-24

DATE: 14/02/2024

SCALE: 1:50 METERS

PROJECT TITLE: CONSTRUCTION OF GSMO QUARTERS FOR 11ID, PA
CAMP BAUTISTA, BUSBUS, JOLO SULU

DESIGNER: *Genesys Bulk*

CLIENT: GSMA

DATE: 14/02/2024

SCALE: 1:50 METERS

PROJECT NO.: 11ID-SBAC-012-24

DATE: 14/02/2024

SCALE: 1:50 METERS

SHEET CONTENTS: AS SHOWN

DRAWN BY: DBA

APPROVED BY: *DANILO L. SANTILLAN*
Major (CE) PA
Chief, A & E Branch

APPROVED BY: *ROSE EDUARDO F. LIBON*
Colonel (CE) PA
Army Chief Engineer

SHEET NO.: A-6

Section VIII. Bill of Quantities

**PLEASE USE THIS BID FORM
DO NOT RETYPE or ALTER**

One (1) unit GSMO Quarters - Page (1/15)

BILL OF QUANTITIES

Construction of GSMO Quarters at 11ID, PA,
Camp Bautista, Busbus, Jolo, Sulu
Bid Ref. No. **11ID SBAC 012-24**
Approved Budget Contract: **PhP4,988,913.00**

INSTRUCTION TO THE BIDDER: Indicate cost per line item. DO NOT LEAVE ANY BLANK. INDICATE "0" IF ITEM IS BEING OFFERED FOR FREE. "NO" ENTRY WILL NOT BE ACCEPTED. FAILURE TO CONFORM WILL RESULT IN A RATING OF "FAILED"

| Description | Qty | Unit | P/Unit | Amount |
|------------------------------|-----|------|------------------|--------|
| I. Earthwork | | | | |
| Labor | | | | |
| Excavation | 50 | cu.m | | |
| Backfill | 50 | cu.m | | |
| Compaction | 86 | cu.m | | |
| Material | | | | |
| Filling Materials | 36 | cu.m | | |
| | | | | |
| | | | Sub-Total | |
| II. Concrete Works | | | | |
| Portland Cement, Type 1 | 335 | Bags | | |
| Washed Sand | 19 | cu.m | | |
| Crushed Gravel 3/4" | 37 | cu.m | | |
| Gravel bedding | 14 | cu.m | | |
| 16mmØ x 6.0 rebars, deformed | 15 | pcs | | |
| 12mmØ x 6.0 rebars, deformed | 140 | pcs | | |

Notes:

- The Financial Bid includes taxes, labor cost and other cost relative to the construction of the project.
- The bidder shall shoulder all transportation costs, delivery charges and shall assume all risks until the goods have been delivered and installed at the project site and accepted by PA.
- The amount in the signed submitted Financial Bid Form (**Annex XI**) must be equal to the sum indicated in the Bill of Quantities per **Section VIII** must not exceed the total ABC

BIDDER'S UNDERTAKING

I/We, the undersigned bidder, have examined the Bidding Documents including Bid Bulletins, as applicable, hereby OFFER to (supply/deliver/perform) the above-described items.

I/We undertake, if our bid is accepted, to deliver the items in accordance with the terms and conditions contained in the bid documents, including the posting of the required performance security within ten (10) calendar days from receipt of Notice of Award.

Until a formal contract/order confirmation is prepared and signed, this Bid is binding on us.

Name of Company (in print)

Name and Signature of Company Authorized Representative

Designation (in print)

Date

**PLEASE USE THIS BID FORM
DO NOT RETYPE or ALTER**

One (1) unit GSMO Quarters - Page (2/15)

BILL OF QUANTITIES

**Construction of GSMO Quarters at 11ID, PA,
Camp Bautista, Busbus, Jolo, Sulu
Bid Ref. No. 11ID SBAC 012-24**

Approved Budget Contract: PhP4,988,913.00

INSTRUCTION TO THE BIDDER: Indicate cost per line item. DO NOT LEAVE ANY BLANK. INDICATE "0" IF ITEM IS BEING OFFERED FOR FREE. "NO" ENTRY WILL NOT BE ACCEPTED. FAILURE TO CONFORM WILL RESULT IN A RATING OF "FAILED"

| Description | Qty | Unit | P/Unit | Amount |
|--|------------|-------------|---------------|---------------|
| 10mmØ x 6.0 rebars, deformed | 396 | pcs | | |
| G.I tie wire #16 | 60 | kgs | | |
| Sub-Total | | | | |
| III. Masonry Works | | | | |
| 6" CHB | 1,800 | Pcs | | |
| 4" CHB | 2,150 | Pcs | | |
| Portland Cement, type 1 | 325 | Bags | | |
| Washed Sand | 38 | cu.m | | |
| 10mmØ x 6.0 rebars, deformed | 198 | pcs | | |
| G.I tie wire #16 | 17 | kgs | | |
| Sub-Total | | | | |
| IV. Form Works | | | | |
| ½" thk marine plywood | 16 | Pcs | | |
| Form lumber coco | 600 | Bd-ft | | |
| CW nails asstd | 22 | Kgs | | |
| Concrete nails | 8 | kgs | | |
| Sub-Total | | | | |
| V. Roofing and Roof Framing Works | | | | |
| Pre-painted long span rib type .5mm | 185 | sq.m | | |
| 10mm thk roof insulation, single side | 4.0 | rolls | | |

Notes:

- The Financial Bid includes taxes, labor cost and other cost relative to the construction of the project.
- The bidder shall shoulder all transportation costs, delivery charges and shall assume all risks until the goods have been delivered and installed at the project site and accepted by PA.
- The amount in the signed submitted Financial Bid Form (**Annex XI**) must be equal to the sum indicated in the Bill of Quantities per **Section VIII** must not exceed the total ABC

BIDDER'S UNDERTAKING

I/We, the undersigned bidder, have examined the Bidding Documents including Bid Bulletins, as applicable, hereby OFFER to (supply/deliver/perform) the above-described items.

I/We undertake, if our bid is accepted, to deliver the items in accordance with the terms and conditions contained in the bid documents, including the posting of the required performance security within ten (10) calendar days from receipt of Notice of Award.

Until a formal contract/order confirmation is prepared and signed, this Bid is binding on us.

Name of Company (in print)

Name and Signature of Company Authorized Representative

Designation (in print)

Date

**PLEASE USE THIS BID FORM
DO NOT RETYPE or ALTER**

One (1) unit GSMO Quarters - Page (3/15)

BILL OF QUANTITIES

**Construction of GSMO Quarters at 11ID, PA,
Camp Bautista, Busbus, Jolo, Sulu
Bid Ref. No. 11ID SBAC 012-24**

Approved Budget Contract: PhP4,988,913.00

INSTRUCTION TO THE BIDDER: Indicate cost per line item. DO NOT LEAVE ANY BLANK. INDICATE "0" IF ITEM IS BEING OFFERED FOR FREE. "NO" ENTRY WILL NOT BE ACCEPTED. FAILURE TO CONFORM WILL RESULT IN A RATING OF "FAILED"

| Description | Qty | Unit | P/Unit | Amount |
|--|------------|-------------|---------------|---------------|
| Pre-painted ridge rill 0.5mmx8' | 18 | pcs | | |
| Teck screw 3" | 1,700 | pcs | | |
| Welding rod | 6 | boxes | | |
| 1/4"x2"x2"x6m angular bar | 80 | pcs | | |
| 1/4"x1 1/2"x1x1 1/2"x6m angular bar | 54 | pcs | | |
| 3/16"x1"x1"x6m angular bar | 26 | pcs | | |
| 1.5mmx2"x4"x6m C-purlins | 62 | pcs | | |
| 10mmØx6m plain bar sag rod | 14 | pcs | | |
| 100mmx250mmx12mm base plate w/ 2-12mmØ anchor bolt w/ nuts & washers | 24 | sets | | |
| Roof sealant | 1 | gal | | |
| Hardi Fascia | 80 | ln-m | | |
| Steel roof louver | 3 | sets | | |
| Sub-Total | | | | |
| VI, Carpentry (Ceiling, Eaves and Cabinets) | | | | |
| 1/4" thk ficem board | 65 | pcs | | |
| 19mmx50mmx0.60mm metal furring x 5mtrs | 195 | pcs | | |
| 12mmx38mmx0.80mm thk carrying channel x 5mtrs | 84 | pcs | | |
| 25mmx25mmx0.50mm thk wall angle xx 5mtrs | 40. | mtrs | | |

Notes:

- The Financial Bid includes taxes, labor cost and other cost relative to the construction of the project.
- The bidder shall shoulder all transportation costs, delivery charges and shall assume all risks until the goods have been delivered and installed at the project site and accepted by PA.
- The amount in the signed submitted Financial Bid Form **(Annex XI)** must be equal to the sum indicated in the Bill of Quantities per **Section VIII** must not exceed the total ABC

BIDDER'S UNDERTAKING

I/We, the undersigned bidder, have examined the Bidding Documents including Bid Bulletins, as applicable, hereby OFFER to (supply/deliver/perform) the above-described items.

I/We undertake, if our bid is accepted, to deliver the items in accordance with the terms and conditions contained in the bid documents, including the posting of the required performance security within ten (10) calendar days from receipt of Notice of Award.

Until a formal contract/order confirmation is prepared and signed, this Bid is binding on us.

Name of Company (in print)

Name and Signature of Company Authorized Representative

Designation (in print)

Date

**PLEASE USE THIS BID FORM
DO NOT RETYPE or ALTER**

One (1) unit GSMO Quarters - Page (4/15)

BILL OF QUANTITIES

Construction of GSMO Quarters at 11ID, PA,
Camp Bautista, Busbus, Jolo, Sulu
Bid Ref. No. **11ID SBAC 012-24**

Approved Budget Contract: **PhP4,988,913.00**

INSTRUCTION TO THE BIDDER: Indicate cost per line item. DO NOT LEAVE ANY BLANK. INDICATE "0" IF ITEM IS BEING OFFERED FOR FREE. "NO" ENTRY WILL NOT BE ACCEPTED. FAILURE TO CONFORM WILL RESULT IN A RATING OF "FAILED"

| Description | Qty | Unit | P/Unit | Amount |
|-------------------------|-----|-------|--------|--------|
| W-clip | 320 | pcs | | |
| Blind rivets | 15 | boxes | | |
| Concrete Nails 1" | 4 | kgs | | |
| cabinet/Closet | 3 | units | | |
| Kitchen counter cabinet | 1 | lot | | |
| Sub-Total | | | | |

VII. Doors & Windows

-doors

D1 – 0.90m x 2.10m panel door duco finished w/ cylindrical lockset complete with 3 LP hinge per leaf, wood jamb

1

set

D2 – 0.80m x 2.10m panel door duco finished w/ cylindrical lockset complete with 3 LP hinge per leaf, wood jamb

5

sets

D3 – 0.70m x 2.10m flush door w/ cylindrical lockset semi-duco fin, w/ cylindrical lockset complete with 3 LP hinge per leaf, wood jamb

1

set

D4 – 0.60m x 2.10m pvc door w/ cylindrical lockset

2

sets

Notes:

- The Financial Bid includes taxes, labor cost and other cost relative to the construction of the project.
- The bidder shall shoulder all transportation costs, delivery charges and shall assume all risks until the goods have been delivered and installed at the project site and accepted by PA.
- The amount in the signed submitted Financial Bid Form (**Annex XI**) must be equal to the sum indicated in the Bill of Quantities per **Section VIII** must not exceed the total ABC

BIDDER'S UNDERTAKING

I/We, the undersigned bidder, have examined the Bidding Documents including Bid Bulletins, as applicable, hereby OFFER to (supply/deliver/perform) the above-described items.

I/We undertake, if our bid is accepted, to deliver the items in accordance with the terms and conditions contained in the bid documents, including the posting of the required performance security within ten (10) calendar days from receipt of Notice of Award.

Until a formal contract/order confirmation is prepared and signed, this Bid is binding on us.

Name of Company (in print)

Name and Signature of Company Authorized Representative

Designation (in print)

Date

**PLEASE USE THIS BID FORM
DO NOT RETYPE or ALTER**

One (1) unit GSMO Quarters - Page (5/15)

BILL OF QUANTITIES

**Construction of GSMO Quarters at 11ID, PA,
Camp Bautista, Busbus, Jolo, Sulu
Bid Ref. No. 11ID SBAC 012-24**

Approved Budget Contract: PhP4,988,913.00

INSTRUCTION TO THE BIDDER: Indicate cost per line item. DO NOT LEAVE ANY BLANK. INDICATE "0" IF ITEM IS BEING OFFERED FOR FREE. "NO" ENTRY WILL NOT BE ACCEPTED. FAILURE TO CONFORM WILL RESULT IN A RATING OF "FAILED"

| Description | Qty | Unit | P/Unit | Amount |
|---|-----|------|--------|--------|
| D5 – 1.50m x 2.10m steel grill door w/ black quick drying enamel paint finished | 1 | set | | |
| W1- 1.20m x 2.40m sliding window on analok frame w/ 6mm thk clear glass with screen on 1 ¾"x4" analok alum jamb | 4 | sets | | |
| W2- 1.20m x 1.20m sliding window on analok frame w/ 6mm thk clear glass with screen on 1 ¾"x4" analok alum jamb | 2 | sets | | |
| W3- 0.90m x 1.20m sliding window on analok frame w/ 6mm thk clear glass with screen on 1 ¾"x4" analok alum jamb | 1 | set | | |
| W4- 0.60m x 0.60m awning window on analok frame w/ 6mm thk clear glass with screen on 1 ¾"x4" analok alum jamb | 2 | sets | | |
| Sub-Total | | | | |
| VIII. Plumbing Works | | | | |
| Water closet with complete fittings/acc | 2 | sets | | |
| Lavatory with faucets & complete fittings/acc | 2 | sets | | |
| Stainless faucets 1/2"Ø | 4 | pcs | | |

Notes:

- The Financial Bid includes taxes, labor cost and other cost relative to the construction of the project.
- The bidder shall shoulder all transportation costs, delivery charges and shall assume all risks until the goods have been delivered and installed at the project site and accepted by PA.
- The amount in the signed submitted Financial Bid Form (**Annex XI**) must be equal to the sum indicated in the Bill of Quantities per **Section VIII** must not exceed the total ABC

BIDDER'S UNDERTAKING

I/We, the undersigned bidder, have examined the Bidding Documents including Bid Bulletins, as applicable, hereby OFFER to (supply/deliver/perform) the above-described items.

I/We undertake, if our bid is accepted, to deliver the items in accordance with the terms and conditions contained in the bid documents, including the posting of the required performance security within ten (10) calendar days from receipt of Notice of Award.

Until a formal contract/order confirmation is prepared and signed, this Bid is binding on us.

Name of Company (in print)

Name and Signature of Company Authorized Representative

Designation (in print)

Date

**PLEASE USE THIS BID FORM
DO NOT RETYPE or ALTER**

One (1) unit GSMO Quarters - Page (6/15)

BILL OF QUANTITIES

**Construction of GSMO Quarters at 11ID, PA,
Camp Bautista, Busbus, Jolo, Sulu
Bid Ref. No. 11ID SBAC 012-24
Approved Budget Contract: PhP4,988,913.00**

INSTRUCTION TO THE BIDDER: Indicate cost per line item. DO NOT LEAVE ANY BLANK. INDICATE "0" IF ITEM IS BEING OFFERED FOR FREE. "NO" ENTRY WILL NOT BE ACCEPTED. FAILURE TO CONFORM WILL RESULT IN A RATING OF "FAILED"

| Description | Qty | Unit | P/Unit | Amount |
|---|-----|-------|--------|--------|
| Stainless Kitchen sink (double tab) comp w/ ftngs & accs. | 1 | set | | |
| Stainless Kitchen sink (single tab) comp w/ ftngs & accs. | 1 | set | | |
| p-tap 2"Ø | 4 | Pcs | | |
| ½" gate valve | 2 | Pcs | | |
| 4"x4" floor drain SS | 3 | pcs | | |
| Mirror on aluminum frame (0.8mx0.6) | 2 | Sets | | |
| Water Line (ppr pipe, fittings & accs.) | 1 | lot | | |
| Sewer Line (orange pipe) | 1 | lot | | |
| Catch basin (0.60 x0.60x1.00 m) | 6 | Units | | |
| Septic vault (1) – 2.70x1.50x1.80m | 1 | unit | | |
| Sub-Total | | | | |
| IX. Painting Works | | | | |
| Skim coat (white) | 16 | bags | | |
| Latex paint semi-gloss | 12 | tins | | |
| Flatwall enamel paint | 7 | tins | | |
| flat latex paint | 5 | tins | | |
| Acri color | 10 | pints | | |

Notes:

- The Financial Bid includes taxes, labor cost and other cost relative to the construction of the project.
- The bidder shall shoulder all transportation costs, delivery charges and shall assume all risks until the goods have been delivered and installed at the project site and accepted by PA.
- The amount in the signed submitted Financial Bid Form (**Annex XI**) must be equal to the sum indicated in the Bill of Quantities per **Section VIII** must not exceed the total ABC

BIDDER'S UNDERTAKING

I/We, the undersigned bidder, have examined the Bidding Documents including Bid Bulletins, as applicable, hereby OFFER to (supply/deliver/perform) the above-described items.
I/We undertake, if our bid is accepted, to deliver the items in accordance with the terms and conditions contained in the bid documents, including the posting of the required performance security within ten (10) calendar days from receipt of Notice of Award.
Until a formal contract/order confirmation is prepared and signed, this Bid is binding on us.

Name of Company (in print)

Name and Signature of Company Authorized Representative

Designation (in print)

Date

**PLEASE USE THIS BID FORM
DO NOT RETYPE or ALTER**

One (1) unit GSMO Quarters - Page (7/15)

BILL OF QUANTITIES

**Construction of GSMO Quarters at 11ID, PA,
Camp Bautista, Busbus, Jolo, Sulu
Bid Ref. No. 11ID SBAC 012-24
Approved Budget Contract: PhP4,988,913.00**

INSTRUCTION TO THE BIDDER: Indicate cost per line item. DO NOT LEAVE ANY BLANK. INDICATE "0" IF ITEM IS BEING OFFERED FOR FREE. "NO" ENTRY WILL NOT BE ACCEPTED. FAILURE TO CONFORM WILL RESULT IN A RATING OF "FAILED"

| Description | Qty | Unit | P/Unit | Amount |
|---|-----|-------|--------|--------|
| Tinting color | 4 | pints | | |
| Roller brush with tray | 8 | sets | | |
| Qde paint | 2 | tins | | |
| Paint thinner | 6 | gals | | |
| Paint brush | 6 | pcs | | |
| Sand paper | 8 | pcs | | |
| Rugs | 4 | kgs | | |
| Sub-Total | | | | |
| X. Electrical Works | | | | |
| a. Lighting Fixtures | | | | |
| LED Panel Light 4.5" 12W, Recessed Type | 29 | sets | | |
| LED Fluorescent T8 1x18W, Surfaced Type | 2 | sets | | |
| LED Emergency Light, 2-bulb | 6 | sets | | |
| Ceiling Fan 1.20mØ w/ Selector Switch | 1 | set | | |
| Exhaust Fan, 30cmx30cm, Ceiling Type | 3 | sets | | |
| b. Wires & Cables | | | | |
| 2.0mm ² THHN wire | 3 | boxes | | |
| 3.5mm ² THHN wire | 12 | boxes | | |
| 5.5mm ² THHN wire | 1 | box | | |

Notes:

- The Financial Bid includes taxes, labor cost and other cost relative to the construction of the project.
- The bidder shall shoulder all transportation costs, delivery charges and shall assume all risks until the goods have been delivered and installed at the project site and accepted by PA.
- The amount in the signed submitted Financial Bid Form (**Annex XI**) must be equal to the sum indicated in the Bill of Quantities per **Section VIII** must not exceed the total ABC

BIDDER'S UNDERTAKING

I/We, the undersigned bidder, have examined the Bidding Documents including Bid Bulletins, as applicable, hereby OFFER to (supply/deliver/perform) the above-described items.

I/We undertake, if our bid is accepted, to deliver the items in accordance with the terms and conditions contained in the bid documents, including the posting of the required performance security within ten (10) calendar days from receipt of Notice of Award.

Until a formal contract/order confirmation is prepared and signed, this Bid is binding on us.

Name of Company (in print)

Name and Signature of Company Authorized Representative

Designation (in print)

Date

**PLEASE USE THIS BID FORM
DO NOT RETYPE or ALTER**

One (1) unit GSMO Quarters - Page (8/15)

BILL OF QUANTITIES

**Construction of GSMO Quarters at 11ID, PA,
Camp Bautista, Busbus, Jolo, Sulu
Bid Ref. No. 11ID SBAC 012-24**

Approved Budget Contract: PhP4,988,913.00

INSTRUCTION TO THE BIDDER: Indicate cost per line item. DO NOT LEAVE ANY BLANK. INDICATE "0" IF ITEM IS BEING OFFERED FOR FREE. "NO" ENTRY WILL NOT BE ACCEPTED. FAILURE TO CONFORM WILL RESULT IN A RATING OF "FAILED"

| Description | Qty | Unit | P/Unit | Amount |
|---|------------|-------------|---------------|---------------|
| 14mm ² THHN wire | 20 | mtrs | | |
| 38mm ² THHN wire | 40 | mtrs | | |
| c. Pipes & Conduits | | | | |
| 20mmØ uPVC pipe | 200 | Pcs | | |
| 20mmØ uPVC long elbow | 100 | pcs | | |
| 32mmØ uPVC pipe | 15 | pcs | | |
| 32mmØ uPVC male adapter w/ locknut | 4 | pcs | | |
| 32mmØ uPVC long elbow | 2 | pcs | | |
| 32mmØ IMC pipe | 1 | pc | | |
| 32mmØ IMC male adapter w/ locknut | 4 | pcs | | |
| d. Wiring Devices | | | | |
| 1-gang switch w/ cover, flush type | 1 | set | | |
| 2-gang switch w/ cover, flush type | 10 | sets | | |
| 3-gang switch w/ cover, flush type | 1 | set | | |
| Convenience Outlet, Duplex, 3-Universal Prong | 25 | sets | | |
| Convenience Outlet, Duplex, Weather Proof, GFCI | 4 | sets | | |
| Range Outlet, 3-Prong Universal | 1 | set | | |

Notes:

- The Financial Bid includes taxes, labor cost and other cost relative to the construction of the project.
- The bidder shall shoulder all transportation costs, delivery charges and shall assume all risks until the goods have been delivered and installed at the project site and accepted by PA.
- The amount in the signed submitted Financial Bid Form (**Annex XI**) must be equal to the sum indicated in the Bill of Quantities per **Section VIII** must not exceed the total ABC

BIDDER'S UNDERTAKING

I/We, the undersigned bidder, have examined the Bidding Documents including Bid Bulletins, as applicable, hereby OFFER to (supply/deliver/perform) the above-described items.

I/We undertake, if our bid is accepted, to deliver the items in accordance with the terms and conditions contained in the bid documents, including the posting of the required performance security within ten (10) calendar days from receipt of Notice of Award.

Until a formal contract/order confirmation is prepared and signed, this Bid is binding on us.

Name of Company (in print)

Name and Signature of Company Authorized Representative

Designation (in print)

Date

**PLEASE USE THIS BID FORM
DO NOT RETYPE or ALTER**

One (1) unit GSMO Quarters - Page (9/15)

BILL OF QUANTITIES

**Construction of GSMO Quarters at 11ID, PA,
Camp Bautista, Busbus, Jolo, Sulu
Bid Ref. No. 11ID SBAC 012-24**

Approved Budget Contract: PhP4,988,913.00

INSTRUCTION TO THE BIDDER: Indicate cost per line item. DO NOT LEAVE ANY BLANK. INDICATE "0" IF ITEM IS BEING OFFERED FOR FREE. "NO" ENTRY WILL NOT BE ACCEPTED. FAILURE TO CONFORM WILL RESULT IN A RATING OF "FAILED"

| Description | Qty | Unit | P/Unit | Amount |
|---|------------|-------------|---------------|---------------|
| ACU Outlet, 3-Prong Universal | 1 | set | | |
| Cable TV Outlet, w/ plate & cover | 4 | sets | | |
| Sub-Total | | | | |
| e. Electrical Devices | | | | |
| Junction Box PVC w/ cover 4"x4"x2" | 51 | sets | | |
| Square box PVC w/ cover 5"x5"x2" | 2 | sets | | |
| Utility Box PVC 4"x2"x2" | 57 | pcs | | |
| Service Entrance Cap 32mmØ, Power | 1 | set | | |
| Service Entrance Cap 20mmØ, Tel. & Wifi/CATV | 2 | sets | | |
| Electrical Tape, big | 15 | pcs | | |
| GI tie wire #16. 1kl | 15 | kgs | | |
| PVC Solvent 400cc | 15 | cans | | |
| g. Panel Board | | | | |
| PB 125AT/200AF MCCB, 230V, 22kaic, 2-Pole, Bolt-On Type, 20-Branches: w/ Grounding Busbar Terminal, NEMA 3R Enclosure | 1 | set | | |

Notes:

- The Financial Bid includes taxes, labor cost and other cost relative to the construction of the project.
- The bidder shall shoulder all transportation costs, delivery charges and shall assume all risks until the goods have been delivered and installed at the project site and accepted by PA.
- The amount in the signed submitted Financial Bid Form (**Annex XI**) must be equal to the sum indicated in the Bill of Quantities per **Section VIII** must not exceed the total ABC

BIDDER'S UNDERTAKING

I/We, the undersigned bidder, have examined the Bidding Documents including Bid Bulletins, as applicable, hereby OFFER to (supply/deliver/perform) the above-described items.

I/We undertake, if our bid is accepted, to deliver the items in accordance with the terms and conditions contained in the bid documents, including the posting of the required performance security within ten (10) calendar days from receipt of Notice of Award.

Until a formal contract/order confirmation is prepared and signed, this Bid is binding on us.

Name of Company (in print)

Name and Signature of Company Authorized Representative

Designation (in print)

Date

**PLEASE USE THIS BID FORM
DO NOT RETYPE or ALTER**

One (1) unit GSMO Quarters - Page (10/15)

BILL OF QUANTITIES

**Construction of GSMO Quarters at 11ID, PA,
Camp Bautista, Busbus, Jolo, Sulu
Bid Ref. No. 11ID SBAC 012-24
Approved Budget Contract: PhP4,988,913.00**

INSTRUCTION TO THE BIDDER: Indicate cost per line item. DO NOT LEAVE ANY BLANK. INDICATE "0" IF ITEM IS BEING OFFERED FOR FREE. "NO" ENTRY WILL NOT BE ACCEPTED. FAILURE TO CONFORM WILL RESULT IN A RATING OF "FAILED"

| Description | Qty | Unit | P/Unit | Amount |
|--|-----|------|--------|--------|
| 17-20AT/50AF, 2P, Miniature Circuit Breaker Type, Bolt-on | | | | |
| 02-30AT/50AF, 2P, Miniature Circuit Breaker Type, Bolt-on | | | | |
| 01-40At/50AF, 2P, Miniature Circuit Breaker Type, Bolt-on | | | | |
| NEMA 3R Enclosure, 20AT/50AF, 2P, 230V, 60Hz | 3 | sets | | |
| ECB 125AT/200AF MCCB, 230V, 2P. 22KAIC, 60Hz, NEMA 3R Enclosure | 1 | set | | |
| h. Outside Electrical Concrete Pedestal, Complete Assembly | 1 | set | | |
| Ground Rod 5/8"Øx3m, w/ clamp, Power & Telephone/Wifi | 2 | sets | | |
| 32mmØ Metal Strap w/ 2-holes & Screws | 8 | sets | | |
| Secondary Rack, 2-Spool | 1 | set | | |
| Sub-Total | | | | |
| XI. Tile Works | | | | |
| 60x60cm floor tiles | 345 | pcs | | |

Notes:

- The Financial Bid includes taxes, labor cost and other cost relative to the construction of the project.
- The bidder shall shoulder all transportation costs, delivery charges and shall assume all risks until the goods have been delivered and installed at the project site and accepted by PA.
- The amount in the signed submitted Financial Bid Form (**Annex XI**) must be equal to the sum indicated in the Bill of Quantities per **Section VIII** must not exceed the total ABC

BIDDER'S UNDERTAKING

I/We, the undersigned bidder, have examined the Bidding Documents including Bid Bulletins, as applicable, hereby OFFER to (supply/deliver/perform) the above-described items.
I/We undertake, if our bid is accepted, to deliver the items in accordance with the terms and conditions contained in the bid documents, including the posting of the required performance security within ten (10) calendar days from receipt of Notice of Award.
Until a formal contract/order confirmation is prepared and signed, this Bid is binding on us.

Name of Company (in print)

Name and Signature of Company Authorized Representative

Designation (in print)

Date

**PLEASE USE THIS BID FORM
DO NOT RETYPE or ALTER**

One (1) unit GDMO Quarters - Page (11/15)

BILL OF QUANTITIES

**Construction of GSMO Quarters at 11ID, PA,
Camp Bautista, Busbus, Jolo, Sulu
Bid Ref. No. 11ID SBAC 012-24
Approved Budget Contract: PhP4,988,913.00**

INSTRUCTION TO THE BIDDER: Indicate cost per line item. DO NOT LEAVE ANY BLANK. INDICATE "0" IF ITEM IS BEING OFFERED FOR FREE. "NO" ENTRY WILL NOT BE ACCEPTED. FAILURE TO CONFORM WILL RESULT IN A RATING OF "FAILED"

| Description | Qty | Unit | P/Unit | Amount |
|---|-----|-------|--------|--------|
| 60x60cm floor tiles – CR & Terrace | 62 | pcs | | |
| 60x60cm floor tiles – CR | 68 | pcs | | |
| Portland cement type 1 | 95 | bags | | |
| washed sand | 11 | cu.m | | |
| Tile adhesive | 95 | bags | | |
| Tile grout – 2kgs/pack | 40 | packs | | |
| Cutting disk | 8 | pcs | | |
| Sub-Total | | | | |
| XII. General Requirements | | | | |
| Temporary facilities | 1 | lot | | |
| Permits requirements | 1 | lot | | |
| Sub-Total | | | | |
| XIII. Fire Safety Requirements | | | | |
| Fire extinguisher ABC dry chemical, 10 lbs | 2 | sets | | |
| Sub-Total | | | | |
| XIV. Amenities | | | | |
| Refrigerator (7-cu.ft. Two door inverter type refrigerator, energy efficient compressor w/ 100 watts) | 1 | unit | | |

Notes:

- The Financial Bid includes taxes, labor cost and other cost relative to the construction of the project.
- The bidder shall shoulder all transportation costs, delivery charges and shall assume all risks until the goods have been delivered and installed at the project site and accepted by PA.
- The amount in the signed submitted Financial Bid Form (**Annex XI**) must be equal to the sum indicated in the Bill of Quantities per **Section VIII** must not exceed the total ABC

BIDDER'S UNDERTAKING

I/We, the undersigned bidder, have examined the Bidding Documents including Bid Bulletins, as applicable, hereby OFFER to (supply/deliver/perform) the above-described items.

I/We undertake, if our bid is accepted, to deliver the items in accordance with the terms and conditions contained in the bid documents, including the posting of the required performance security within ten (10) calendar days from receipt of Notice of Award.

Until a formal contract/order confirmation is prepared and signed, this Bid is binding on us.

Name of Company (in print)

Name and Signature of Company Authorized Representative

Designation (in print)

Date

PLEASE USE THIS BID FORM
DO NOT RETYPE or ALTER

One (1) unit GSMO Quarters - Page (12/15)

BILL OF QUANTITIES

**Construction of GSMO Quarters at 11ID, PA,
Camp Bautista, Busbus, Jolo, Sulu
Bid Ref. No. 11ID SBAC 012-24
Approved Budget Contract: PhP4,988,913.00**

INSTRUCTION TO THE BIDDER: Indicate cost per line item. DO NOT LEAVE ANY BLANK. INDICATE "0" IF ITEM IS BEING OFFERED FOR FREE. "NO" ENTRY WILL NOT BE ACCEPTED. FAILURE TO CONFORM WILL RESULT IN A RATING OF "FAILED"

| Description | Qty | Unit | P/Unit | Amount |
|--|-----|-------|--------|--------|
| Gas range (4-gas burners with wok burner cast iron pan full electric ignition, minute minder gas oven/gas grill 3 cooking function) w/ LPG tank | 1 | set | | |
| 60cmx60cm range hood | 1 | set | | |
| 8kg topload fully automatic washing machine | 1 | unit | | |
| Sala set Sofa: 2pcs – 2 seater w/ side table Black leather on Uratex foam | 1 | set | | |
| Dining sets, six seaters (table & chairs) Materials: wood, color: Oak table dimension: L-150, W-90, H-74cm chair dimension: L-47, w-44,H-99, SH-47, LH-38cm | 1 | set | | |
| Double size bed Dimension: 54"x75 Headboard, Slats and Footboard material: Metal Post: Solid wood | 3 | units | | |

Notes:

- The Financial Bid includes taxes, labor cost and other cost relative to the construction of the project.
- The bidder shall shoulder all transportation costs, delivery charges and shall assume all risks until the goods have been delivered and installed at the project site and accepted by PA.
- The amount in the signed submitted Financial Bid Form (**Annex XI**) must be equal to the sum indicated in the Bill of Quantities per **Section VIII** must not exceed the total ABC

BIDDER'S UNDERTAKING

I/We, the undersigned bidder, have examined the Bidding Documents including Bid Bulletins, as applicable, hereby OFFER to (supply/deliver/perform) the above-described items.

I/We undertake, if our bid is accepted, to deliver the items in accordance with the terms and conditions contained in the bid documents, including the posting of the required performance security within ten (10) calendar days from receipt of Notice of Award.

Until a formal contract/order confirmation is prepared and signed, this Bid is binding on us.

Name of Company (in print)

Name and Signature of Company Authorized Representative

Designation (in print)

Date

**PLEASE USE THIS BID FORM
DO NOT RETYPE or ALTER**

One (1) unit GSMO Quarters - Page (13/15)

BILL OF QUANTITIES

**Construction of GSMO Quarters at 11ID, PA,
Camp Bautista, Busbus, Jolo, Sulu
Bid Ref. No. 11ID SBAC 012-24
Approved Budget Contract: PhP4,988,913.00**

INSTRUCTION TO THE BIDDER: Indicate cost per line item. DO NOT LEAVE ANY BLANK. INDICATE "0" IF ITEM IS BEING OFFERED FOR FREE. "NO" ENTRY WILL NOT BE ACCEPTED. FAILURE TO CONFORM WILL RESULT IN A RATING OF "FAILED"

| Description | Qty | Unit | P/Unit | Amount |
|--|------------|-------------|---------------|---------------|
| Combination of wood and steel elements for a modern touch Malaysian solid wood post with Metal headboard, slats and footboard. Matte painted finish for Metal and Natural finish for post with vertical support and 5 th leg for stability. Mattress thickness 4 inches 54"x75 | | | | |
| Kitchen utensils (1 doz spoon big, 1doz fork big, 1 doz plate w/ glasses, cups & saucers, 6 pcs of bowl) | 2 | sets | | |
| Cooking utensils (2-pcs frying pan 8" & 14"Ø, 2-pots/boiler 6" & 10"Ø) 2-pcs kitchen knife, 6 pcs stainless ladle & spatula (asstd.) | 1 | set | | |
| Electric kettle (2L, 1,500 watts, 220V, boiling time 5 mins) | 2 | pcs | | |
| Linen, bedsheets & pillow (for single bed) | 4 | sets | | |
| 20L microwave oven (700 watts) | 1 | unit | | |
| Water dispenser (hot and cold) | 1 | unit | | |

Notes:

- The Financial Bid includes taxes, labor cost and other cost relative to the construction of the project.
- The bidder shall shoulder all transportation costs, delivery charges and shall assume all risks until the goods have been delivered and installed at the project site and accepted by PA.
- The amount in the signed submitted Financial Bid Form (**Annex XI**) must be equal to the sum indicated in the Bill of Quantities per **Section VIII** must not exceed the total ABC

BIDDER'S UNDERTAKING

I/We, the undersigned bidder, have examined the Bidding Documents including Bid Bulletins, as applicable, hereby OFFER to (supply/deliver/perform) the above-described items.
I/We undertake, if our bid is accepted, to deliver the items in accordance with the terms and conditions contained in the bid documents, including the posting of the required performance security within ten (10) calendar days from receipt of Notice of Award.
Until a formal contract/order confirmation is prepared and signed, this Bid is binding on us.

Name of Company (in print)

Name and Signature of Company Authorized Representative

Designation (in print)

Date

**PLEASE USE THIS BID FORM
DO NOT RETYPE or ALTER**

One (1) unit GSMO Quarters - Page (14/15)

BILL OF QUANTITIES

**Construction of GSMO Quarters at 11ID, PA,
Camp Bautista, Busbus, Jolo, Sulu
Bid Ref. No. 11ID SBAC 012-24
Approved Budget Contract: PhP4,988,913.00**

INSTRUCTION TO THE BIDDER: Indicate cost per line item. DO NOT LEAVE ANY BLANK. INDICATE "0" IF ITEM IS BEING OFFERED FOR FREE. "NO" ENTRY WILL NOT BE ACCEPTED. FAILURE TO CONFORM WILL RESULT IN A RATING OF "FAILED"

| Description | Qty | Unit | P/Unit | Amount |
|--|-----|------|--------|--------|
| 1.0HP ACU, Split Type, Wall Mounted, Inverter, remote complete installation w/ accessories | 2 | sets | | |
| 1.5HP ACU, Split Type, Wall Mounted, Inverter, remote complete installation w/ accessories | 1 | set | | |
| Shower Water heater, 3,500W | 2 | sets | | |
| Telephone Corded Handset | 2 | sets | | |
| Sub-Total | | | | |
| Total | | | | |
| | | | | |
| | | | | |
| | | | | |
| | | | | |
| | | | | |
| | | | | |
| | | | | |
| | | | | |
| | | | | |
| | | | | |
| | | | | |
| | | | | |
| | | | | |
| | | | | |
| | | | | |
| | | | | |
| | | | | |
| | | | | |
| | | | | |
| | | | | |
| | | | | |

- Notes:**
- The Financial Bid includes taxes, labor cost and other cost relative to the construction of the project.
 - The bidder shall shoulder all transportation costs, delivery charges and shall assume all risks until the goods have been delivered and installed at the project site and accepted by PA.
 - The amount in the signed submitted Financial Bid Form (**Annex XI**) must be equal to the sum indicated in the Bill of Quantities per **Section VIII** must not exceed the total ABC

BIDDER'S UNDERTAKING

I/We, the undersigned bidder, have examined the Bidding Documents including Bid Bulletins, as applicable, hereby OFFER to (supply/deliver/perform) the above-described items.
I/We undertake, if our bid is accepted, to deliver the items in accordance with the terms and conditions contained in the bid documents, including the posting of the required performance security within ten (10) calendar days from receipt of Notice of Award.
Until a formal contract/order confirmation is prepared and signed, this Bid is binding on us.

Name of Company (in print)

Name and Signature of Company Authorized Representative

Designation (in print)

Date

**PLEASE USE THIS BID FORM
DO NOT RETYPE or ALTER**

One (1) unit GSMO Quarters – Page (15/15)

BILL OF QUANTITIES

**Construction of GSMO Quarters at 11ID, PA,
Camp Bautista, Busbus, Jolo, Sulu
Bid Ref. No. 11ID SBAC 012-24
Approved Budget Contract: PhP4,988,913.00**

| Description | Sub-total |
|--|-----------|
| I. Earthworks (materials) | |
| II. Concrete Works (Including Rebars) | |
| III. Masonry Works | |
| IV. Form Works | |
| V. Roofing and Roof Framing Works | |
| VI. Carpentry (Ceiling, Eaves & Cabinets) | |
| VII. Doors and Windows | |
| VIII. Plumbing Works | |
| IX. Paintings Works | |
| X. Electrical Works | |
| XI. Tile Works | |
| Total Material Cost | |
| Labor | |
| XII. Earthworks (Labor) | |
| XIII. Steel Scaffoldings (rental) | |
| XIV. General Requirements | |
| XV. Fire Safety Requirements | |
| XVI. Amenities | |
| VAT | |
| Overhead | |
| Miscellaneous | |
| Contractor's Profit | |
| Total | |

Notes:

- The Financial Bid includes taxes, labor cost and other cost relative to the construction of the project.
- The bidder shall shoulder all transportation costs, delivery charges and shall assume all risks until the goods have been delivered and installed at the project site and accepted by PA.
- The amount in the signed submitted Financial Bid Form (**Annex XI**) must be equal to the sum indicated in the Bill of Quantities per **Section VIII** must not exceed the total ABC

BIDDER'S UNDERTAKING

I/We, the undersigned bidder, have examined the Bidding Documents including Bid Bulletins, as applicable, hereby OFFER to (supply/deliver/perform) the above-described items.
I/We undertake, if our bid is accepted, to deliver the items in accordance with the terms and conditions contained in the bid documents, including the posting of the required performance security within ten (10) calendar days from receipt of Notice of Award.
Until a formal contract/order confirmation is prepared and signed, this Bid is binding on us.

Name of Company (in print)

Name and Signature of Company Authorized Representative

Designation (in print)

Date

Section IX. Checklist of Technical and Financial Documents

Checklist of Technical and Financial Documents

| | |
|---|--|
| <p>In accordance with Clause 15 of the Instructions to Bidders, The Bid shall be signed on every page and or initialed by the duly authorized representative/s of the bidder to include all photocopies. Any document that was not signed and/or initialed by the authorized representative/s of the bidder shall be as ground for disqualification.</p> | |
| ENVELOP 1: TECHNICAL COMPONENT | |
| | |
| | |
| TAB | Class "A" Documents |
| Legal Documents | |
| A | Valid and updated PhilGEPS Registration Certificate (Platinum Membership) in accordance with Section 8.5.2 of the revised IRR of RA No. 9184 (updated 15 January 2024 and GPPB Resolution 15-2021 dated 14 October 2021.) (Annex I-A) |
| Technical Documents | |
| B | <p>Duly signed statement of all ongoing government and private contracts, including contracts awarded but not yet started. (Annex I-B)</p> <p>The bidder may make a reservation under oath in a notarized document not to disclose the name of its client on the ground of an existing confidentiality agreement but must disclose the amount, status, and name of the project for purposes of validating the NFCC, subject to the full disclosure during post-qualification. In this connection, the bidder may keep the name of the client from the statement of ongoing contracts.</p> |
| C | <p>Statement of Single Largest Completed Contract similar to the contract to be bid equivalent to at least Fifty (50%) of the total ABC of the project (Annex I-C).</p> <p>However contractors under small A and small B categories without similar experience on the contract to be bid may be allowed to bid if the cost of such contract is not more than the Allowable Range of Contract Cost (ARCC) of their registration based on the guidelines as prescribed by the PCAB. Provided, Bidder submits a duly notarized affidavit that it has no similar experience on the contract.</p> <p>Similar contract(s) must be supported by the following documents to be submitted during Post-Qualification:</p> <ol style="list-style-type: none"> a. Constructor's Performance Evaluation System (CPES) Final Rating which must be Satisfactory, <u>or</u> b. Owner's Certificate of Acceptance, <u>or</u> c. Owner's Certificate of Completion <p>Similar contracts shall refer to contracts involving Construction of Vertical/Horizontal Structure/Building.</p> |
| D | <p>Valid and current Philippine Contractors Accreditation Board (PCAB) license with Classification/Category in General Building/General Engineering with Minimum Size Range Small B and Minimum License Category of C&D</p> <p>The PCAB license must indicate "PCAB registered contractor for Government Projects."</p> |

| | | |
|----------------------------|--|-----------------------------|
| | Note: In case of Joint Venture Agreement (JVA), both partners must possess a valid PCAB license, in addition to the Special PCAB license issued in favor of the JV. | |
| E | <p>Original copy of Bid Security. If in the form of a Surety Bond, submit also a certification issued by the Insurance Commission;</p> <p>or</p> <p>Original copy of Notarized Bid Securing Declaration (Annex III) in an amount not less than the required percentage of the ABC in accordance with the following schedule:</p> <p>a) Cash, Cashier's Check or Manager's Check* equivalent to amount of not less PhP99,778.26 (2% of ABC);</p> <p>b) Surety Bond callable upon demand equivalent to amount of not less than PhP249,445.65 (5% of ABC).</p> <p><i>*Must be issued by a Local Universal or Local Commercial Bank</i></p> | |
| F | <p>Project Requirements, which shall include the following:</p> <p>1) Organizational chart for the contract to be bid;</p> <p>2) List of contractor's personnel (viz, Licensed Civil Engineer, Materials Engineer, Registered Electrical Engineer, Master Plumber, Safety Officer, and Construction Foreman), to be assigned to the contract to be bid, with their complete qualification and experience data (Bio Data) and</p> <p>3) List of contractor's equipment units, which are owned, leased and/or under purchase agreements, supported by certification of availability of equipment from the equipment lessor/vendor for the duration of the project.</p> | |
| G | Completed and signed Technical Bid Form and other Technical Documents | |
| | 1 | Refer to Section VI |
| | 2 | Refer to Section VII |
| | 3 | Annex V |
| H | Affidavit of Undertaking for the Project's Technical Specifications Bid Form and its Drawing/Plan (Annex VI) | |
| I | Certificate of Site Inspection issued by the Commanding Officer, 11IMB, IMCOM, PA. | |
| J | <p>Certificate of Performance Evaluation (Annex VII) Showing a rating of at least Satisfactory, issued by the Bidder's client of the Single Largest Completed Contract of Similar Nature per submitted Annex I-C;</p> <p>However Contractors with no Similar Experience must submit a duly notarized Affidavit that it has no similar experience on the contract.</p> | |
| K | Omnibus Sworn Statement in accordance with Section 25.3 of the 2016 Revised IRR of RA 9184 and using the form prescribed in Annex VIII | |
| Financial Documents | | |
| L | <p>Duly signed Certificate of Net Financial Contracting Capacity (NFCC) per Annex IX, in accordance with ITB Clause 5.5 or Committed Line of Credit.</p> <p>The computation must be at least equal to the ABC of the project. The detailed computation using the required formula must be shown as provided for in Annex II-A.</p> | |

| | |
|----------|--|
| | <p>NFCC = [(Current assets minus current liabilities) (15)] minus the value of all outstanding or uncompleted portions of the projects under ongoing contracts, including awarded contracts yet to be started, coinciding with the contract to be bid.</p> <p>Notes:</p> <ol style="list-style-type: none"> 1. The phrase “the values of the bidder’s current assets and current liabilities” shall be based on the data submitted to the BIR, which refers to the values of the current assets and current liabilities reflected in the Annual Income Tax Return and Audited Financial Statements. 2. The value of all outstanding or uncompleted contracts refers to those listed in Annex I-B. 3. The detailed computation must be shown using the required formula provided above. 4. The NFCC computation must at least be equal to the ABC of the project. <p>If the prospective bidder opts to submit a Committed Line of Credit, it must be at least equal to ten percent (10%) of the ABC of the project issued by local universal or commercial bank which must be effective or available on the date of bid submission. The amount of Committed Line of Credit MUST BE MACHINE VALIDATED. (See sample Bank Form per Annex II-A)</p> |
| | Class “B” Documents |
| M | <p>Valid Joint Venture Agreement (JVA), in case the joint venture is already in existence, or, duly notarized statements from all potential joint venture partners stating that they will enter into and abide by the provisions of the JVA in the instance that the bids is successful; Failure to enter into a joint venture in the event of a contract award shall be ground for the forfeiture of the bid security.</p> <ol style="list-style-type: none"> a. Each JV Partner must submit the PhilGEPS Certificate of Registration (Platinum Membership). b. For other required Class “A” Eligibility Documents; submission by any of the partner(s) constitutes collective compliance. <p>In case JVA is not applicable, the bidder must submit a statement stating that JVA is not applicable in lieu of the foregoing (Annex II-B).</p> |
| N | <p>Proof of Authority of the designated representative/s for purposes of the bidding</p> <p>For Local Bidder:</p> <ol style="list-style-type: none"> a) Duly notarized Special Power of Attorney – For Sole Proprietorship if owner opts to designate a representative/s; OR b) Duly notarized Secretary’s Certificate evidencing the authority of the designated representative/s, issued by the corporation, cooperative or the members of the joint venture. <p>For Foreign Bidder:</p> <ol style="list-style-type: none"> a) Valid and Current Written Appointment of the Philippine based company (as local representative of foreign manufacturer) issued by the foreign bidder. The written appointment must include detailed scope of responsibility of the local |

representative. A Certified True Copy of the Written Appointment may be submitted subject to the presentation of the original document during post qualification; AND

b) Duly Notarized authorization of the duly registered Philippine-based company representative (e.g. Secretary's Certificate for Corporation, Special Power of Attorney for Sole Proprietor) with specimen signature of the authorized representative to transact with PA/AFP including address, telephone number/mobile phone number, and email address;

OR

c) In case the authorized local representative is an individual (citizen of the Philippines), a Valid and Current Written Appointment of the said individual as the local representative issued by the foreign bidder must be submitted. The written appointment must include detailed scope of responsibility of the local representative with specimen signature of the authorized representative to transact with PA/AFP, including address, telephone number or mobile phone number and email address. A Certified True Copy of the Written Appointment may be submitted subject to the presentation of the original document during post qualification.

Note 1 (for both local and foreign bidders): Provided that in the case of unincorporated joint venture, each member shall submit their respective Special Power of Attorney and/or Secretary's Certificate evidencing the authority of the designated representatives for purposes of this bidding

Note 2 (for both local and foreign bidders): The Secretary's Certificate, Board Resolution or Special Power of Attorney, or its equivalent document/proof of authority of the designated representative/s for purposes of the bidding, must have a specimen signature of the bidder or its authorized representative; it must indicate in the said document the authority to transact with the Philippine Army/AFP; it must be specific to the project; and it must indicate in the same document the address, telephone number/mobile phone number, and email address of the bidder or its authorized representative.

Note 3 (for both local and foreign bidders): In case of Joint Venture, bidder must submit an Original Special Power of Attorney wherein all members of the Joint Venture are signatories, giving full power and authority to the designated representative of the Joint Venture to sign the OSS and to do acts to represent the bidder.

Certificate from Armed Forces of the Philippines Procurement Service (AFPPS) **that the Bidder is not Blacklisted and has No Overdue Delivery. (Annex X)**

O

In the absence of the said Certificate, the Bidder shall submit a proof of application of the same stamped received by AFFPS if manually filed, or acknowledged received by the AFPPS through its official email address: afppsthree@gmail.com if electronically filed.

Note 1: In case of Joint Venture, each JV partner shall submit the same certificate.

Note 2: Over-due delivery shall mean undelivered or incomplete delivery of items after the due date of delivery or approved request for extension of delivery period.

ENVELOP 2: FINANCIAL COMPONENT

| | |
|----------|--|
| A | Original of duly signed and accomplished Financial Bid Form (Annex XI-A) |
| | Original of duly signed Bid Form (Annex XI-B) |
| B | Original of duly signed Bid Prices in the Bill of Quantities (Section VIII) |

Annexes

TABLE OF CONTENTS

| | |
|----------------------|--|
| | Technical Documents |
| Annex I-A | PhilGEPS Certificate of Registration (Platinum Membership) |
| Annex I-B | Statement of All Ongoing Government and Private Contracts |
| Annex I-C | Statement of Single Largest Completed Contract |
| Annex II-A | Committed Line of Credit |
| Annex II-B | Statement stating that JVA is not Applicable |
| Annex III | Bid-Securing Declaration |
| Annex IV-A | Organizational Chart |
| Annex IV-B | Bio Data |
| Annex IV-C | List of Constructor's Equipment |
| Refer to Section VI | Technical Specifications |
| Refer to Section VII | Drawings: Hard Copy |
| Annex V | Scope of Works |
| Annex VI | Affidavit of Undertaking |
| Annex VII | Certificate of Performance Evaluation |
| Annex VIII | Omnibus Sworn Statement |
| Annex IX | NFCC Computation |
| Annex X | Certificate from Armed Forces of the Philippines Procurement Service (AFPPS) that the Bidder is not Blacklisted and has No Overdue Delivery. |
| | Financial Component |
| Annex XI-A | Financial Bid Form |
| Annex XI-B | Bid Form |
| Section VIII | Bill of Quantities |

Annex I-A
(Sample)

Republic of the Philippines
Department of Budget and Management
PROCUREMENT SERVICE
CERTIFICATE OF PHILGEPS REGISTRATION
(Platinum Membership)

THIS IS TO CERTIFY THAT

_____,
_____, Philippines

is registered in the **Philippine Government Electronic Procurement System (PhilGEPS)** on 14-Oct-2010 pursuant to Section 8.5.2 of the Revised Implementing Rules and Regulations of Republic Act No. 9184, otherwise known as the Government Procurement Reform Act.

This further certifies that _____ has submitted the required eligibility documents in the PhilGEPS Supplier Registry as listed in Annex A, which document is attached hereto and made an integral part hereof.

For the purpose of updating this Certificate, all Class "A" eligibility documents covered by Section 8.5.2 of the Revised Implementing Rules and Regulations of Republic Act No. 9184 supporting the veracity, authenticity and validity of this Certificate shall remain current and updated. The failure by the prospective Bidder to update this Certificate with the current and updated Class "A" eligibility documents shall result in the automatic suspension of its validity until such time that all of the expired Class "A" eligibility documents has been updated.

By submitting this Certificate, the Bidder certifies:

1. the authenticity, genuineness, validity, and completeness of the copy of the original eligibility documents submitted;
2. the veracity of the statements and information contained therein;
3. that the Certificate is not a guaranty that the named registrant will be declared eligible without first being determined to be such for that particular bidding, nor is it an evidence that the Bidder has passed the post-qualification stage; and
4. that any finding of concealment, falsification, or misrepresentation of any of the eligibility documents submitted, or the contents thereof shall be a ground for disqualification from further participation in the bidding process, without prejudice to the imposition of appropriate administrative, civil and criminal penalty in accordance with the laws.

This Certificate is valid until 01-Apr-2023

Issued this 01st day of April 2022.
This is a system generated certificate. No signature is required.

CERTIFIED TRUE COP



Documentary Stamp Tax Paid Php 30.00
Certificate Reference No: _____

Page 1 of 3

Note: All attached documents of "Annex A" must be updated.

**Annex I-A
(Sample)****REMINDERS ¹**

- *The PhilGEPS office shall not determine the eligibility of merchants. The PhilGEPS office's evaluation of the eligibility requirements shall be for the sole purpose of determining the approval or disapproval of the merchant's application for registration.*
- *A merchant's registration and membership in the GOP-OMR is neither contract-specific nor understood to be tantamount to a finding of eligibility. Neither shall the merchant's successful registration in the GOP-OMR be relied upon to claim eligibility for the purpose of participation in any public bidding.*
- *The determination of the eligibility of merchants, whether registered with the GOP-OMR or not, shall remain with the Bids and Awards Committee (BAC). The BAC's determination of validity of the eligibility requirements shall be conclusive to enable the merchant to participate in the public bidding process.*

CERTIFIED TRUE COPY

Certificate Reference No: [REDACTED]

Page 2 of 3

¹Refer to Section 4 of the Guidelines for the Use of the Government of the Philippines - Official Merchant's Registry

Note: All attached documents of "Annex A" must be updated.

Annex I-A
(Sample)

"Annex A"

List of Eligibility Documents

of

| | |
|------------------------------------|---|
| DTI Certificate | DTI Certificate Number : 1207229 Issued By / Signatory : RAMON M LOPEZ Registration Date : 22-Oct-2019 Expiration Date : 22-Oct-2024 |
| Mayors Permit | Expiration Date : 31-Dec-2022 Permit Number : 37730R Place of Issue : ZAMBOANGA CITY Issued By / Signatory : MARIA ISABELLE G. CLIMACO Issuance Date : 15-Feb-2022 |
| Tax Clearance | Expiration Date : 08-Mar-2023 TCC Number : 15-93A-03-08-RO192-2022M Issued By / Signatory : TERESITA C. CHIONG Issuance date : 07-Mar-2022 |
| Audited Financial Statement | Date of Filing : 09-Apr-2021 Current Asset : 24,045,626.00 Total Asset : 52,623,026.00 Current Liabilities : 0.00 Total Liabilities : 52,623,026.00 Name of Auditor : SHELDA B. JIKIRI BIR RDO Code : 93A |
| PCAB License | Expiration Date : 30-Jun-2022 Issued By / Signatory : ERIC G. BAGGAO HERBERT DG MATIENZO SERGIE T RETOME Issuance Date : 02-Jul-2021 License Number : 34562 License First Issue Date : 24-Jun-2010 Principal Classification : GENERAL ENGINEERING Category : A |

CERTIFIED TRUE COPY

Certificate Reference No:

Page 3 of 3

Note: All attached documents of "Annex A" must be updated.

Annex I-B

(BIDDER’S COMPANY LETTERHEAD)

**Construction of GSMO Quarters at 11ID, PA,
Camp Bautista, Busbus, Jolo, Sulu
Bid Ref. No. 11ID SBAC 012-24
Approved Budget Contract: PhP4,988,913.00**

**STATEMENT OF ALL ON-GOING GOVERNMENT AND PRIVATE CONTRACTS
(INCLUDING CONTRACTS AWARDED BUT NOT YET STARTED)**

If the contractor has no ongoing contracts, indicate “NONE”.

| Name of the Contract | Date of Contract | Contract Duration | Nature of Work | Owner’s Name and Address | Contractor’s Role (whether sole contractor, subcontractor, or partner in a JV) and percentage of participation |
|-----------------------------|-------------------------|--------------------------|-----------------------|---------------------------------|---|
| | | | | | |
| | | | | | |

| Total Contract at Value Award | Date of Completion or Estimated Completion time | Total Value at Completion (if applicable) | Percentages of planned & actual accomplishments (if applicable) | Value of Outstanding works (if applicable) |
|--------------------------------------|--|--|--|---|
| | | | | |
| | | | | |

Note: Original/Certified True Copies of POs/Contracts/Notice to proceed to be presented only during Post Qualification if declared as the S/LCB.

CERTIFIED CORRECT:

Name of Company (in print)

Name and Signature of Company Authorized Representative

Designation (in print)

Date

Annex I-C

(BIDDER’S COMPANY LETTERHEAD)

**Construction of GSMO Quarters at 11ID, PA,
Camp Bautista, Busbus, Jolo, Sulu
Bid Ref. No. 11ID SBAC 012-24
Approved Budget Contract: PhP4,988,913.00**

STATEMENT OF SINGLE LARGEST COMPLETED CONTRACT SIMILAR TO THIS PROJECT, EQUIVALENT TO AT LEAST FIFTY PERCENT (50%) OF THE ABC.

| Name of the Contract | Contract Duration and Nature of Work | Owner’s Name and Address | Contractor’s Role (whether sole contractor, subcontractor, or partner in a JV) and percentage of participation | Total Contract at Value Award | Date of Completion or Estimated Completion time | Date Contract or Notice to Proceed |
|----------------------|--------------------------------------|--------------------------|--|-------------------------------|---|------------------------------------|
| | | | | | | |
| | | | | | | |

For purposes of this project, similar contracts shall refer to contracts involving Construction or Repair of Building.

Copy of any of the following documents must be attached to this Statement:

- 3. Constructor’s Certificate of Performance Evaluation System (CPES) Final Rating which must be Satisfactory rating, or
- 4. Owner’s Certificate of Acceptance, or
- 5. Owner’s Certificate of Completion.

CERTIFIED CORRECT:

Name of Company (in print)

Name and Signature of Company Authorized Representative

Designation (in print)

Date

(NAME OF BANK)
COMMITTED LINE OF CREDIT

Date: _____

Philippine Army Bids and Awards Committee 3
Fort Andres Bonifacio, Taguig City

| | | |
|----------------------------|---|-------|
| CONTRACT/PROJECT | : | _____ |
| COMPANY FIRM | : | _____ |
| ADDRESS | : | _____ |
| BANK/FINANCING INSTITUTION | : | _____ |
| ADDRESS | : | _____ |
| AMOUNT | : | _____ |

This is to certify that the above Bank/Financing Institution with Business address indicated above, commits to provide the (Supplier/Distributor/Manufacturer/Contractor), if awarded the above-mentioned Contract, a credit line in the amount specified above which shall be exclusively used to finance the performance of the above-mentioned contract subject to the terms, conditions and requirements.

The credit line which must be effective or available on the date of Bid Submission and such line of credit shall be maintained until issuance of the Certificate of Acceptance.

This Certification is being issued in favor of said (Supplier/Distributor/Manufacturer/Contractor) in connection with the bidding requirement of (Name of Procuring Entity) for the above-mentioned Contract. We are aware that any false statement issued by us make us liable for perjury.

This Committed line of credit cannot be terminated or cancelled without the prior written approval of the Philippine Army.

Name and Signature of Authorized Financing Institution Office

Official Designation

Concurred by:

Name and Signature of Supplier/Distributor/Manufacturer/Contractor authorized representative

Official Designation

Amount should be machine validated

(BIDDER'S COMPANY LETTERHEAD)

**Construction of GSMO Quarters at 11ID, PA,
Camp Bautista, Busbus, Jolo, Sulu
Bid Ref. No. 11ID SBAC 012-24
Approved Budget Contract: PhP4,988,913.00**

This is to certify that _____ (name of bidder) _____ will be participating without a joint venture partner in the _____ (name of project) _____. Further, the undersigned acknowledges that Joint Venture Agreement is Not Applicable for the above mentioned project.

CERTIFIED CORRECT:

Name and Signature of Bidder/Authorized Representative

Position

Date

[JURAT]

SUBSCRIBED AND SWORN to before me this ___ day of _____ at _____, Philippines, by the affiant/s himself/herself/themselves whom I was able to personally identify through his/her/their *[insert type of government identification card used]*, which he/she/they has/have presented to me.

Witness my hand and seal this ___ day of *[month]* *[year]*.

Doc No: _____
Page No: _____
Book No: _____
Series of: _____

NOTARY PUBLIC

Annex III

(REPUBLIC OF THE PHILIPPINES)
CITY OF _____) S.S.

Bid-Securing Declaration

**Construction of GSMO Quarters at 11ID, PA,
Camp Bautista, Busbus, Jolo, Sulu
Bid Ref. No. 11ID SBAC 012-24
Approved Budget Contract: PhP4,988,913.00**

**To: Philippine Army Bids and Awards Committee 3
Fort Andres Bonifacio, Taguig City**

I/We, the undersigned, declare that:

1. I/We understand that, according to your conditions, bids must be supported by a Bid Security, which may be in the form of a Bid-Securing Declaration.
2. I/We accept that: (a) I/we will be automatically disqualified from bidding for any contract with any procuring entity for a period of two (2) years upon receipt of your Blacklisting Order; and, (b) I/we will pay the applicable fine provided under Section 6 of the Guidelines on the Use of Bid Securing Declaration, within fifteen (15) days from receipt of written demand by the procuring entity for the commission of acts resulting to the enforcement of the bid securing declaration under Sections 23.1(b), 34.2, 40.1 and 69.1, **except 69.1 (f)**, of the IRR of RA 9184; without prejudice to other legal action the government may undertake.
3. I/We understand that this Bid-Securing Declaration shall cease to be valid on the following circumstances:
 - a. Upon expiration of the bid validity period, or any extension thereof pursuant to your request;
 - b. I am/we are declared ineligible or post-disqualified upon receipt of your notice to such effect, and (i) I/we failed to timely file a request for reconsideration or (ii) I/we filed a waiver to avail of said right;
 - c. I am/we are declared as the bidder with the Lowest Calculated Responsive Bid, and I/we have furnished the performance security and signed the Contract.

IN WITNESS WHEREOF, I/We have hereunto set my/our hand/s this ____ day of [month] [year] at [place of execution].

[Insert NAME OF BIDDER'S
AUTHORIZED REPRESENTATIVE]
[Insert signatory's legal capacity]
Affiant

SUBSCRIBED AND SWORN to before me this ____ day of _____ at _____, Philippines, by the affiant/s himself/herself/themselves whom I was able to personally identify through his/her/their *[insert type of government identification card used]*, which he/she/they has/have presented to me.

Witness my hand and seal this ____ day of [month] [year].

Doc No: _____
Page No: _____
Book No: _____
Series of: _____

NOTARY PUBLIC

Annex IV-A

(Sample Format)

(BIDDER'S COMPANY LETTERHEAD)

**Construction of GSMO Quarters at 11ID, PA,
Camp Bautista, Busbus, Jolo, Sulu
Bid Ref. No. 11ID SBAC 012-24
Approved Budget Contract: PhP4,988,913.00**

ORGANIZATIONAL CHART

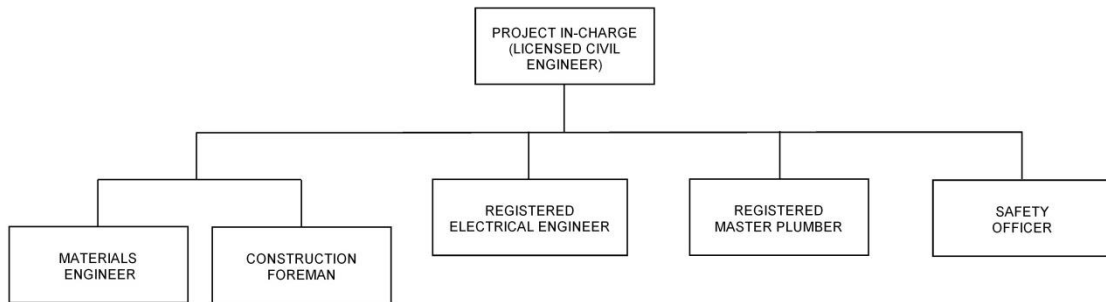

CERTIFIED CORRECT:

Name of Company (in print)

Name and Signature of Company Authorized Representative

Designation (in print)

Date

(Sample Format)

(BIDDER’S COMPANY LETTERHEAD)

**Construction of GSMO Quarters at 11ID, PA,
Camp Bautista, Busbus, Jolo, Sulu
Bid Ref. No. 11ID SBAC 012-24
Approved Budget Contract: PhP4,988,913.00**

List of Contractor’s Personnel

| Name | Designation | General Experience (number of years) | Relevant Experience (number of years) |
|------|-------------|--------------------------------------|---------------------------------------|
| | | | |
| | | | |
| | | | |
| | | | |
| | | | |
| | | | |
| | | | |

CERTIFIED CORRECT:

Name of Company (in print)

Name and Signature of Company Authorized Representative

Designation (in print)

Date

Annex IV-C

(BIDDER'S COMPANY LETTERHEAD)

**Construction of GSMO Quarters at 11ID, PA,
Camp Bautista, Busbus, Jolo, Sulu
Bid Ref. No. 11ID SBAC 012-24
Approved Budget Contract: PhP4,988,913.00**

BIO DATA**PERSONAL DATA**

Name : _____

Date of Birth : _____

Nationality : _____

Marital Status : _____

Permanent : _____

Address : _____

EDUCATIONAL QUALIFICATIONS

| EDUCATION | SCHOOL/INSTITUTION | INCLUSIVE DATES |
|------------------|---------------------------|------------------------|
| Primary | | |
| Secondary | | |
| Tertiary | | |
| Post Grad. | | |

PROFESSIONAL QUALIFICATIONS

Membership in Professional Institutions:

| NAME OF INSTITUTION | ADDRESS |
|----------------------------|----------------|
| | |
| | |

Work Experiences (Listed in descending chronological order)

Present / Most Recent Assignment:

| INCLUSIVE DATES | COMPANY | POSITION / DESIGNATION | BRIEF DESCRIPTION OF DUTIES AND RESPONSIBILITIES |
|------------------------|----------------|-------------------------------|---|
| | | | |
| | | | |

NOTE:

For Licensed Architects/Engineers, please attach certified true copy of valid and current copy of PRC license.

CERTIFIED TRUE AND CORRECT:
(NAME AND SIGNATURE)

Annex IV-D

**Construction of GSMO Quarters at 11ID, PA,
Camp Bautista, Busbus, Jolo, Sulu
Bid Ref. No. 11ID SBAC 012-24
Approved Budget Contract: PhP4,988,913.00**

List of Equipment, Owned or Leased and/or under Purchase Agreements

Business Name:
Business Address:

| Description | Owned/ Leased/ Under Purchase Agreement | Model/ Year | Capacity/ Performa nce/ Size | Plate No. | Motor No./ Body No. | Location | Condition | Proof of Ownership/ Lessor or Vendor |
|-------------|---|----------------|---------------------------------------|--------------|------------------------------|----------|-----------|---|
| 1. | | | | | | | | |
| 2. | | | | | | | | |
| 3. | | | | | | | | |
| 4. | | | | | | | | |
| 5. | | | | | | | | |
| 6. | | | | | | | | |
| 7. | | | | | | | | |
| 8. | | | | | | | | |
| 9. | | | | | | | | |
| 10. | | | | | | | | |
| 11. | | | | | | | | |
| 12. | | | | | | | | |
| 13. | | | | | | | | |
| 14. | | | | | | | | |
| 15. | | | | | | | | |

Submitted by: _____
(Name and Signature of Authorized Representative)

Designation: _____

Date: _____

(Sample Format)

(BIDDER'S COMPANY LETTERHEAD)

**Construction of GSMO Quarters at 11ID, PA,
Camp Bautista, Busbus, Jolo, Sulu
Bid Ref. No. 11ID SBAC 012-24
Approved Budget Contract: PhP4,988,913.00**

PERT/CPM

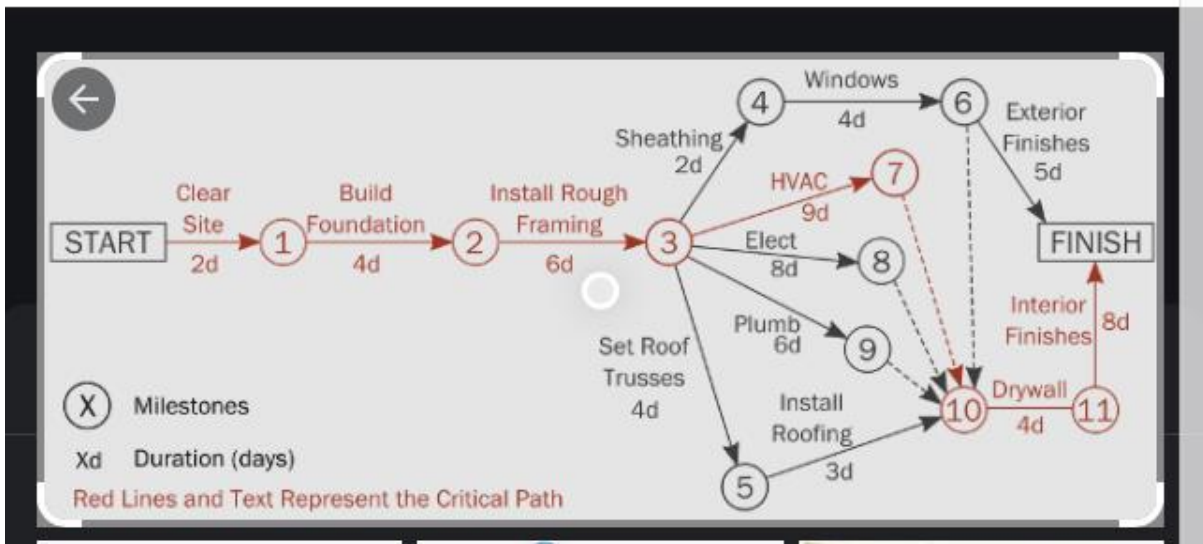

Submitted by: _____
(Name and Signature of Authorized Representative)

Designation: _____

Date: _____

(Sample Format)

(BIDDER'S COMPANY LETTERHEAD)

**Construction of GSMO Quarters at 11ID, PA,
Camp Bautista, Busbus, Jolo, Sulu
Bid Ref. No. 11ID SBAC 012-24
Approved Budget Contract: PhP4,988,913.00**

Gantt Cart and S Curve

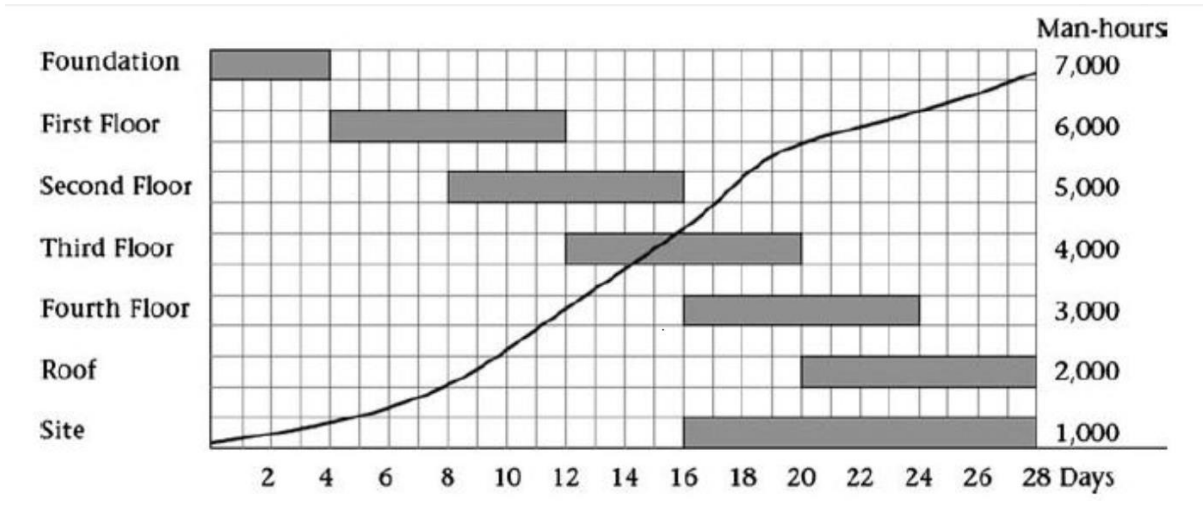

Submitted by: _____
(Name and Signature of Authorized Representative)

Designation: _____

Date: _____

(Sample Format)

(BIDDER’S COMPANY LETTERHEAD)

**Construction of GSMO Quarters at 11ID, PA,
Camp Bautista, Busbus, Jolo, Sulu
Bid Ref. No. 11ID SBAC 012-24
Approved Budget Contract: PhP4,988,913.00**

Manpower Schedule

| MANPOWER SCHEDULE | | DURATION IN DAYS | | | | | | | | | | | | | | | | | | | | | | | |
|-------------------|----------------------|------------------|-------------------|-----------|-----------|-----------|-----------|-----------|-----------|-----------|-----------|-----------|-----------|-----------|-----------|-----------|-----------|-----------|-----------|-----------|-----------|-----------|-----------|-----------|-----|
| ITEM | DESCRIPTION | 5 | 10 | 15 | 20 | 25 | 30 | 35 | 40 | 45 | 50 | 55 | 60 | 65 | 70 | 75 | 80 | 85 | 90 | 95 | 100 | 105 | 110 | 115 | 120 |
| | | 1 | Project in Charge | 1 | 1 | 1 | 1 | 1 | 1 | 1 | 1 | 1 | 1 | 1 | 1 | 1 | 1 | 1 | 1 | 1 | 1 | 1 | 1 | 1 | 1 |
| 2 | Master Electrician | | | | 1 | 1 | 1 | 1 | | | | | | | 1 | 1 | 1 | 1 | 1 | | | | | | |
| 3 | Master Plumber | | | | | 1 | 1 | 1 | 1 | | | | | | | | | | | 1 | 1 | 1 | 1 | | |
| 4 | Safety Officer | 1 | 1 | 1 | 1 | 1 | 1 | 1 | 1 | 1 | 1 | 1 | 1 | 1 | 1 | 1 | 1 | 1 | 1 | 1 | 1 | 1 | 1 | 1 | |
| 5 | Material Engineer | | | 1 | | | 1 | 1 | | | | 1 | 1 | | | | | 1 | 1 | 1 | | | 1 | 1 | |
| 6 | Construction Foreman | 1 | 1 | 1 | 1 | 1 | 1 | 1 | 1 | 1 | 1 | 1 | 1 | 1 | 1 | 1 | 1 | 1 | 1 | 1 | 1 | 1 | 1 | 1 | |
| 7 | Mason | | | 2 | 2 | 2 | 2 | 2 | 2 | 2 | 2 | 2 | 2 | 2 | 2 | 2 | 2 | 2 | 2 | | | | | | |
| 8 | Welder | | | | | | | | | | | | 1 | 1 | 1 | 1 | 1 | 1 | 1 | | | | | | |
| 9 | Steelman | | | | | | 2 | 2 | 2 | 2 | 2 | 2 | 2 | | | | | | | | | | | | |
| 10 | Installer | | | | | | | | | | | | | | | | | | | 2 | 2 | 2 | 2 | 2 | |
| 15 | Laborer | 5 | 5 | 5 | 5 | 8 | 8 | 8 | 8 | 8 | 8 | 8 | 8 | 8 | 8 | 8 | 8 | 8 | 8 | 8 | 8 | 5 | 5 | 5 | |
| | TOTAL | 8 | 8 | 11 | 11 | 15 | 18 | 18 | 16 | 15 | 15 | 16 | 17 | 14 | 15 | 16 | 17 | 17 | 19 | 14 | 13 | 10 | 11 | 10 | |

Submitted by: _____
(Name and Signature of Authorized Representative)

Designation: _____

Date: _____

(Sample Format)

(BIDDER’S COMPANY LETTERHEAD)

**Construction of GSMO Quarters at 11ID, PA,
Camp Bautista, Busbus, Jolo, Sulu
Bid Ref. No. 11ID SBAC 012-24
Approved Budget Contract: PhP4,988,913.00**

| EQUIPMENT UTILIZATION SCHEDULE | | DURATION IN DAYS | | | | | | | | | | | | | | | | | | | | | | | |
|--------------------------------|------------------|------------------|-----------------|----|----|----|----|----|----|----|----|----|----|----|----|----|----|----|----|----|-----|-----|-----|-----|-----|
| ITEM | DESCRIPTION | 5 | 10 | 15 | 20 | 25 | 30 | 35 | 40 | 45 | 50 | 55 | 60 | 65 | 70 | 75 | 80 | 85 | 90 | 95 | 100 | 105 | 110 | 115 | 120 |
| | | 1 | Welding Machine | | | | | | 1 | 1 | 1 | 1 | 1 | 1 | 1 | 1 | 1 | 1 | 1 | 1 | 1 | | | | |
| 2 | Electric drill | 2 | 2 | 2 | 2 | 2 | 2 | 2 | 2 | 2 | 2 | 2 | 2 | 2 | 2 | 2 | 2 | 2 | 2 | 2 | 2 | 2 | 2 | 2 | 2 |
| 3 | Electric Grinder | 2 | 2 | 2 | 2 | 2 | 2 | 2 | 2 | 2 | 2 | 2 | 2 | 2 | 2 | 2 | 2 | 2 | 2 | 2 | 2 | 2 | 2 | 2 | 2 |
| 4 | Dump Truck | 1 | 1 | | | | | | | | | 1 | | | | | 1 | | | | | | | 1 | 1 |
| 5 | Concrete Mixer | | | | 1 | 1 | 1 | 1 | 1 | 1 | 1 | 1 | 1 | 1 | 1 | 1 | 1 | 1 | 1 | 1 | 1 | | | | |
| TOTAL | | 5 | 5 | 4 | 5 | 5 | 6 | 6 | 6 | 6 | 6 | 7 | 6 | 6 | 6 | 6 | 7 | 6 | 6 | 6 | 5 | 4 | 4 | 5 | 5 |

Submitted by: _____
(Name and Signature of Authorized Representative)

Designation: _____

Date: _____

Scope of Works

**Construction of GSMO Quarters at 11ID, PA,
Camp Bautista, Busbus, Jolo, Sulu
Bid Ref. No. 11ID SBAC 012-24
Approved Budget Contract: PhP4,988,913.00**

Project: Construction of GSMO Quarters
Location: Camp Bautista, Busbus, Jolo, Sulu
Floor Area: 125 sqm.

SCOPE of WORKS

- I. Earth Works(labor)**
- a. structure excavation
 - b. backfill/compaction of excavated portion
 - c. clearing / cleaning of site
- Earth Works(materials)**
- a. installation of earth and gravel filling materials
- II. Concrete Works**
- a. installation of re-bars and concreting of foundation, column and footing tie beam
 - b. installation of re-bars and concreting of slab on grade
- III. Masonry Works**
- a. CHB laying on walls and partitions
 - b. plastering of CHB walls and partitions
 - c. plastering of columns and beams
- IV. Form Works**
- a. installation of forms & scaffolds
 - b. removal of forms & scaffolds
- V. Roofing and Roof Framing Works**
- a. fabrication and installation of steel roof frame
 - b. installation of pre-painted long span-rib type roofing w/ complete pre-painted accessories
 - c. installation of steel roof louver
 - d. installation of hardi fascia
 - e. installation of roof insulation
- VI. Carpentry (Ceiling, Eaves and Cabinets)**
- a. installation of ficem board ceiling on metal framing with complete accessories
 - b. installation of eaves ceiling with complete accessories
 - c. fabrication and installation cabinet / closet
 - d. fabrication and installation kitchen counter cabinets
- VII. Doors and Windows**
- a. installation of panel door duco finished w/ cylindrical lockset complete w/ 3 LP hinges per leaf w/ wood jamb
 - b. installation of flush door w/ cylindrical lockset semi-duco finished w/ cylindrical lockset w/ wood jamb
 - c. installation of PVC door w/ cylindrical lockset
 - d. installation of steel grill door w/ black quick drying enamel paint finished
 - e. installation of sliding window on analok frame w/ clear glass and screen on analok alum jamb
 - f. installation of awning window on analok frame w clear glass and screen on analok lum jamb
- VIII. Plumbing Works**
- a. installation of water closet w/ complete fittings/acc
 - b. installation of lavatory w/ faucets & complete fittings/acc
 - c. installation of stainless faucet w/ complete fittings/acc
 - d. installation of floor drain w/ complete fittings/acc
 - e. fabrication and installation of facial mirror on wood frame, paint finish
 - f. installation of comfort room fixtures with complete acc

CONFORME:

Name of Company (in print)

Name and Signature of Company Authorized Representative

Date

Scope of Works

**Construction of GSMD Quarters at 11ID, PA,
Camp Bautista, Busbus, Jolo, Sulu
Bid Ref. No. 11ID SBAC 012-24
Approved Budget Contract: PhP4,988,913.00**

- g. fabrication and installation of frosted glass shower partition/door*
- h. installation of water line with complete fittings/acc*
- i. installation of sewer line*
- j. construction of catch basin and septic vault*

IX. Painting works

- a. application of skimcoat and sanding to smoothen surface*
- b. application of primer paint*
- c. application of finish painting for both masonry, carpentry and steel works*

X. Electrical Works

- a. installation of complete pipes and conduits*
- b. installation of complete electrical devices*
- c. installation of complete wires and cables*
- d. installation of complete wiring devices*
- e. installation of panel board w/ complete acc*
- f. installation of complete lighting fixtures*
- g. installation of outside electrical w/ complete accessories*

XI. Tile Works

- a. installation of 60x60 floor tiles*
- b. installation of 60x60 CR and terrace*
- c. installation of 60x60 CR wall tiles*

XII. General Requirements

- a. erection of temporary facilities*
- b. application of permit requirements*

XIII. Fire Safety Requirements

- a. Installation of fire extinguishers ABC dry chemical*

XIV. Amenities (Delivery and installation)

- a. delivery of refrigerator*
- b. delivery and installation of gas range w/ range hood*
- c. delivery of washing machine*
- d. delivery of sofas and dining sets*
- e. delivery and installation of double size bed*
- f. delivery of kitchen utensils, cooking utensils and complete kitchen acc*
- g. delivery of water dispenser*
- h. delivery and installation of air conditioning units*
- i. Installation of shower head heater*
- j. Installation of telephone corded handset*

Prepared by:



Francisco P. Crisostomo

Engineer III

| |
|---|
| CONFORME: |
| _____ |
| Name of Company (in print) |
| _____ |
| Name and Signature of Company Authorized Representative |
| _____ |
| Date |

Scope of Works

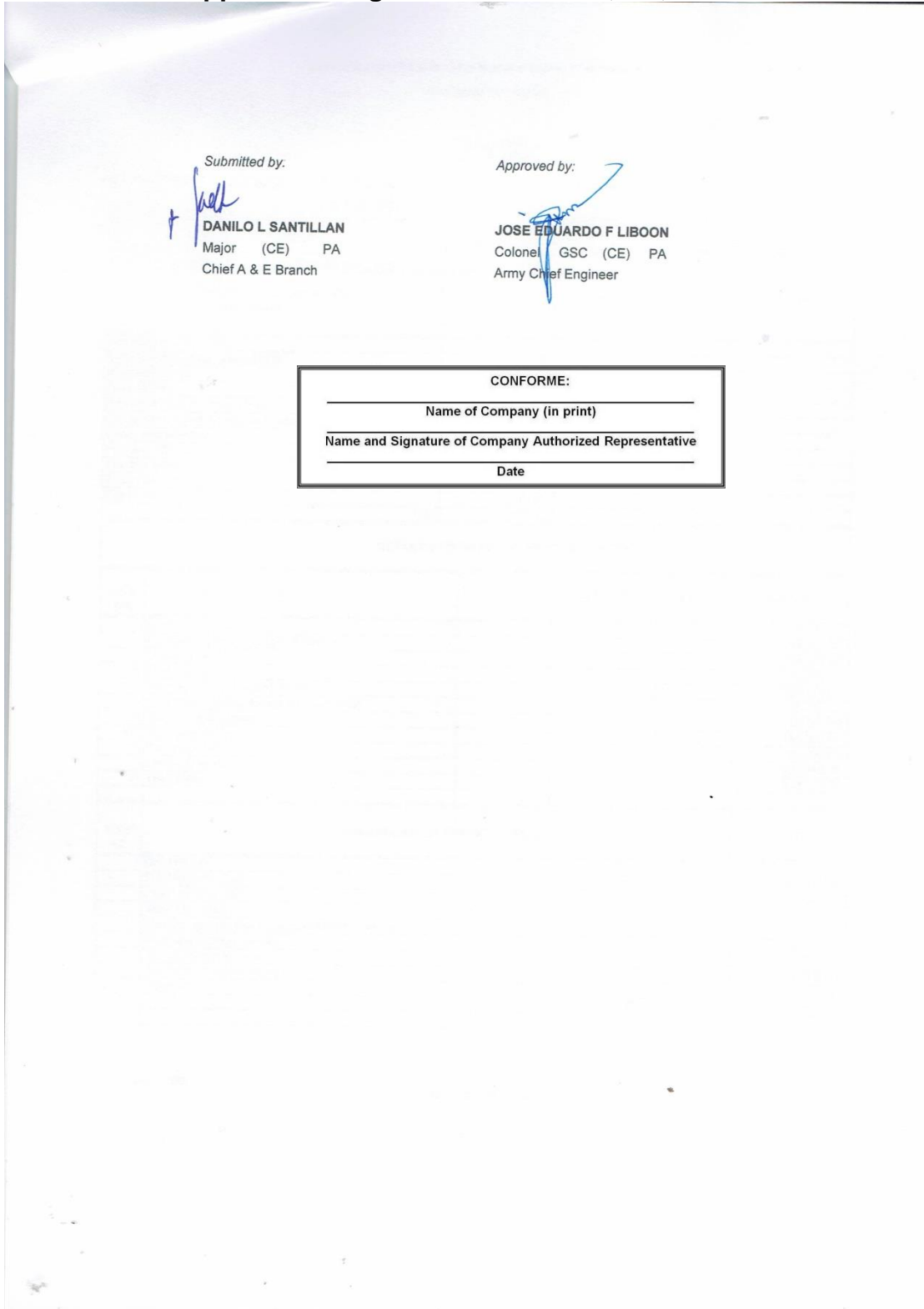
Construction of GSMO Quarters at 11ID, PA,
Camp Bautista, Busbus, Jolo, Sulu
Bid Ref. No. **11ID SBAC 012-24**
Approved Budget Contract: PhP4,988,913.00



Annex VI

(BIDDER'S COMPANY LETTERHEAD)

**Construction of GSMO Quarters at 11ID, PA,
Camp Bautista, Busbus, Jolo, Sulu
Bid Ref. No. 11ID SBAC 012-24
Approved Budget Contract: PhP4,988,913.00**

Affidavit of Undertaking

1. I/We, _____, of legal age, after having been duly sworn in accordance with law, hereby depose and state that:
2. I/We am/are the bidder/s in the Project: **Construction of Ground Development for 155mm SP Howitzer of AAR, PA at Fort Magsaysay, Nueva Ecija**. I/We declare that I have read each and every page of the above-stated project's Scope of Works for the **Construction of Ground Development for 155mm SP Howitzer of AAR, PA at Fort Magsaysay, Nueva Ecija**, including its All Plan, which we acknowledge to have received in hard copy size A3 on _____.
3. I/We understand that having issued this Affidavit of Undertaking, we conform to the requirements of the above-stated Project's Scope of Works for the **Construction of Ground Development for 155mm SP Howitzer of AAR, PA at Fort Magsaysay, Nueva Ecija**. and that, in the event that the contract for the Project is awarded to us, we undertake to complete and accomplish our obligations in accordance with, among other terms and conditions, the said Scope of Works.
4. I/We evaluated the Bill of Quantities (BOQ), Program of Works, Detailed Architectural and Engineering Plans, and if there is discrepancy on plans but indicated on the BOQ or lacking quantity but reflected on the plans, both shall be applied and construed in favor to the government.
5. This Affidavit forms part of our Technical Bid for the above-mentioned Project.
6. I/We are executing this Affidavit to attest to the truth of the foregoing facts.

IN WITNESS WHEREOF, I/We have hereunto set our hand and affix my/our signature/s on this ____ day of [month] [year] at [place of execution].

(Name of Affiant/Bidder's Authorized Representative)

Signature

Position in the Company

Date

SUBSCRIBED AND SWORN to before me this ____ day of _____ at _____, Philippines, by the affiant/s himself/herself/themselves whom I was able to personally identify through his/her/their *[insert type of government identification card used]*, which he/she/they has/have presented to me.

Witness my hand and seal this ____ day of [month] [year].

Doc No: _____
Page No: _____
Book No: _____
Series of: _____

NOTARY PUBLIC

Annex VII

(BIDDER'S CLIENT'S COMPANY LETTERHEAD)

**Construction of GSMO Quarters at 11ID, PA,
Camp Bautista, Busbus, Jolo, Sulu
Bid Ref. No. 11ID SBAC 012-24
Approved Budget Contract: PhP4,988,913.00**

CERTIFICATE OF PERFORMANCE EVALUATION

Issued by Bidder's Completed Single Largest Contract Client as indicated in the submitted
Annex I-C

"Must show rating of at least Satisfactory"

This is to certify that **(NAME OF BIDDER)**, has contracted and performed with our
company/agency the **(NAME of CONTRACT/WORKS)**.

Based on our evaluation, **(NAME OF BIDDER)**, we give a rating of;

- EXCELLENT
 VERY SATISFACTORY
 SATISFACTORY
 POOR

Level of performance throughout the term of the contract based on the following
performance criteria.

- 1) Quality of service delivered;
- 2) Time management;
- 3) Management and suitability of personnel;
- 4) Contract administration and management; and
- 5) Provision of regular progress reports.

This Certification shall form part of the Technical Documentary Requirements in line with
(Name of Bidder) participation in the **Construction of Ground Development for 155mm SP
Howitzer of AAR, PA at Fort Magsaysay, Nueva Ecija.**

Issued this ___ day of _____ 20___, in _____, Philippines

Name of Company (Bidder's Client)

Full Name of Authorized Representative
(Bidder's Client)

Address (Bidder's Client)

Signature of Authorized Representative
(Bidder's Client)

Tel. No. / Fax (Bidder's Client)

E-mail Address (Bidder's Client)

Annex VIII

Omnibus Sworn Statement

REPUBLIC OF THE PHILIPPINES)
 CITY/MUNICIPALITY OF _____) S.S.

AFFIDAVIT

I, *[Name of Affiant]*, of legal age, *[Civil Status]*, *[Nationality]*, and residing at *[Address of Affiant]*, after having been duly sworn in accordance with law, do hereby depose and state that:

1. **Select one, delete the other:**

If a sole proprietorship: I am the sole proprietor or authorized representative of *[Name of Bidder]* with office address at *[address of Bidder]*;

If a partnership, corporation, cooperative, or joint venture: I am the duly authorized and designated representative of *[Name of Bidder]* with office address at *[address of Bidder]*;

2. **Select one, delete the other:**

If a sole proprietorship: As the owner and sole proprietor, or authorized representative of *[Name of Bidder]*, I have full power and authority to do, execute and perform any and all acts necessary to participate, submit the bid, and to sign and execute the ensuing contract for *[Name of the Project]* of the *[Name of the Procuring Entity]*, as shown in the attached duly notarized Special Power of Attorney;

If a partnership, corporation, cooperative, or joint venture: I am granted full power and authority to do, execute and perform any and all acts necessary to participate, submit the bid, and to sign and execute the ensuing contract for *[Name of the Project]* of the *[Name of the Procuring Entity]*, as shown in the attached *[state title of attached document showing proof of authorization (e.g., duly notarized Secretary's Certificate, Board/Partnership Resolution, or Special Power of Attorney, whichever is applicable;)]*;

3. *[Name of Bidder]* is not "blacklisted" or barred from bidding by the Government of the Philippines or any of its agencies, offices, corporations, or Local Government Units, foreign government/foreign or international financing institution whose blacklisting rules have been recognized by the Government Procurement Policy Board by itself or by relation, membership, association, affiliation, or controlling interest with another blacklisted person or entity as defined and provided for in the Uniform Guidelines on Blacklisting, **by itself or by relation, membership, association, affiliation, or controlling interest with another blacklisted person or entity as defined and provided for in the Uniform Guidelines on Blacklisting;**

4. Each of the documents submitted in satisfaction of the bidding requirements is an authentic copy of the original, complete, and all statements and information provided therein are true and correct;

5. *[Name of Bidder]* is authorizing the Head of the Procuring Entity or its duly authorized representative(s) to verify all the documents submitted;

6. **Select one, delete the rest:**

If a sole proprietorship: The owner or sole proprietor is not related to the Head of the Procuring Entity, members of the Bids and Awards Committee 3 (BAC3), the Technical Working Group, and the BAC3 Secretariat, the head of the Project Management Office or the end-user unit, and the project consultants by consanguinity or affinity up to the third civil degree;

If a partnership or cooperative: None of the officers and members of *[Name of Bidder]* is related to the Head of the Procuring Entity, members of the Bids and Awards Committee (BAC3), the Technical Working Group, and the BAC3 Secretariat, the head of the Project Management Office or the end-user unit, and the project consultants by consanguinity or affinity up to the third civil degree;

If a corporation or joint venture: None of the officers, directors, and controlling stockholders of *[Name of Bidder]* is related to the Head of the Procuring Entity, members of the Bids and Awards Committee 3 (BAC3), the Technical Working Group, and the BAC3 Secretariat, the head of the Project Management Office or the end-user unit, and the project consultants by consanguinity or affinity up to the third civil degree;

7. *[Name of Bidder]* complies with existing labor laws and standards; and

8. *[Name of Bidder]* is aware of and has undertaken the following responsibilities as a Bidder:

- a) Carefully examine all of the Bidding Documents;
- b) Acknowledge all conditions, local or otherwise, affecting the implementation of the Contract;
- c) Made an estimate of the facilities available and needed for the contract to be bid, if any; and
- d) Inquire or secure Supplemental/Bid Bulletin(s) issued for the *[Name of the Project]*.

9. *[Name of Bidder]* did not give or pay directly or indirectly, any commission, amount, fee, or any form of consideration, pecuniary or otherwise, to any person or official, personnel or representative of the government in relation to any procurement project or activity.

10. **In case advance payment was made or given, failure to perform or deliver any of the obligations and undertakings in the contract shall be sufficient grounds to constitute criminal liability for Swindling (Estafa) or the commission of fraud with unfaithfulness or abuse of confidence through misappropriating or converting any payment received by a person or entity under an obligation**

involving the duty to deliver certain goods or services, to the prejudice of the public and the government of the Philippines pursuant to Article 315 of Act No. 3815 s. 1930, as amended, or the Revised Penal Code.

IN WITNESS WHEREOF, I have hereunto set my hand this ___ day of ___, 20___ at _____, Philippines.

[Insert NAME OF BIDDER OR ITS AUTHORIZED REPRESENTATIVE]
[Insert signatory’s legal capacity]
Affiant

SUBSCRIBED AND SWORN to before me this ___ day of _____ at _____, Philippines, by the affiant/s himself/herself/themselves whom I was able to personally identify through his/her/their *[insert type of government identification card used]*, which he/she/they has/have presented to me.

Witness my hand and seal this ___ day of *[month]* *[year]*.

NAME OF NOTARY PUBLIC

Serial No. of Commission _____
Notary Public for _____ until _____
Roll of Attorneys No. _____
PTR No. _____ *[date issued]*, *[place issued]*
IBP No. _____ *[date issued]*, *[place issued]*

Doc No: _____
Page No: _____
Book No: _____
Series of: _____

* This form will not apply for WB funded projects.

Annex IX

(BIDDER’S COMPANY LETTERHEAD)

Construction of GSMO Quarters at 11ID, PA,
 Camp Bautista, Busbus, Jolo, Sulu
 Bid Ref. No. **11ID SBAC 012-24**
 Approved Budget Contract: PhP4,988,913.00

Certificate of Net Financial Contracting Capacity

This is to certify that our **NET FINANCIAL CONTRACTING CAPACITY (NFCC)** is Philippine Pesos _____ (PHP _____) which is at least equal to the total ceiling price we are bidding. The amount is computed as follows:

| | | | |
|--------------------|---|--|-----|
| CA | = | | PHP |
| Less: | | | - |
| CL | = | | |
| Sub-Total 1 | | | PHP |
| | | | x15 |
| Sub-Total 2 | | | PHP |
| Less: | | | - |
| C | = | Value of all outstanding or uncompleted portions of the projects under on-going contracts, including awarded contracts yet to be started coinciding with the contract for this Project | PHP |
| NFCC | | | PHP |

Issued this__ day of_____ 20__.

Notes:

1. The value of all outstanding or uncompleted contracts refers to those listed in Annex I.
2. The detailed computation must be shown using the required formula provided above.
3. The NFCC computation must at least be equal to the ABC of the project.

CERTIFIED CORRECT:

Name of Company (in print)

Name and Signature of Company Authorized Representative

Designation (in print)

Date

Annex X
(Sample)

HEADQUARTERS
ARMED FORCES OF THE PHILIPPINES PROCUREMENT SERVICE
Camp General Emilio Aguinaldo, Quezon City

AFPPS3
 Nr **-2019**

20 November 2019

CERTIFICATION

TO WHOM IT MAY CONCERN:

THIS IS TO CERTIFY THAT _____ has the following procurement project with corresponding status with reference to the consolidated reports from the Procurement Centers and Contracting Offices this Service as of **31 October 2019**:

| Nr | PC/CO | PO/ Contract Nr | Particulars | Bid Price (Php) | Remarks /Status |
|-----------|--------------|------------------------|---------------------------------|------------------------|------------------------|
| 1 | PA PC | ENG-20190711-3891 | S/D Construction Materials | 498,000.00 | For signature of DIIR |
| 2 | PA PC | ENG-001-06-19 | 1-LOT-ENHANCEMENT OF ST MICHAEL | 1,346,749.00 | For Delivery |

Further, per Government Procurement Policy Board (GPPB) Website, subject company is not in the list of Blacklisted Suppliers/Constructors as of date.

This certification is issued in favor of same company in relation with the requirement for bidding of procurement project/s by the **PA Bids and Awards Committee (PA BAC)**.

This certification does not exempt same company from any foregoing requisites the **PABAC** may require or conduct during the course of the proceedings pursuant to the provisions of RA 9184 and its IRR.

JOSELITO C. MUNAR
 LTC PAF (GSC)
 ACS for Operations, PS3

AFP Core Values: Honor, Service, Patriotism

**PLEASE USE THIS BID FORM
DO NOT RETYPE or ALTER**

Annex XI-A1.1

FINANCIAL BID FORM

**Construction of GSMO Quarters at 11ID, PA,
Camp Bautista, Busbus, Jolo, Sulu
Bid Ref. No. 11ID SBAC 012-24
Approved Budget Contract: PhP4,988,913.00**

INSTRUCTION TO THE BIDDER: Indicate cost per line item. DO NOT LEAVE ANY BLANK. INDICATE "0" IF ITEM IS BEING OFFERED FOR FREE. "NO" ENTRY WILL NOT BE ACCEPTED. FAILURE TO CONFORM WILL RESULT IN A RATING OF "FAILED"

| Description | ABC | Bidder's Proposal |
|--|-------------------------------|-------------------|
| <p>Construction of GSMO Quarters at 11ID, PA, Camp Bautista, Busbus, Jolo, Sulu</p> | <p>PhP4,988,913.00</p> | |

Total Bid Price (Amount in Words):

Notes:

- The Financial Bid includes taxes, labor cost and other cost relative to the construction of the project.
- The bidder shall shoulder all transportation costs, delivery charges and shall assume all risks until the goods have been delivered and installed at the project site and accepted by PA.
- The amount in the signed submitted Financial Bid Form (**Annex XI**) must be equal to the sum indicated in the Bill of Quantities per **Section VIII** must not exceed the total ABC

BIDDER'S UNDERTAKING

I/We, the undersigned bidder, have examined the Bidding Documents including Bid Bulletins, as applicable, hereby OFFER to (supply/deliver/perform) the above-described items.

I/We undertake, if our bid is accepted, to deliver the items in accordance with the terms and conditions contained in the bid documents, including the posting of the required performance security within ten (10) calendar days from receipt of Notice of Award.

Until a formal contract/order confirmation is prepared and signed, this Bid is binding on us.

Name of Company (in print)

Name and Signature of Company Authorized Representative

Designation (in print)

Date

Annex XI-B.1

BID FORM

**Construction of GSMO Quarters at 11ID, PA,
Camp Bautista, Busbus, Jolo, Sulu
Bid Ref. No. 11ID SBAC 012-24
Approved Budget Contract: PhP4,988,913.00**

Date : _____

To: *[name and address of Procuring Entity]*

Having examined the Philippine Bidding Documents (PBDs) including the Supplemental or Bid Bulletin Numbers *[insert numbers]*, the receipt of which is hereby duly acknowledged, we, the undersigned, declare that:

- a. We have no reservation to the PBDs, including the Supplemental or Bid Bulletins, for the Procurement Project: *[insert name of contract]*;
- b. We offer to execute the Works for this Contract in accordance with the PBDs;
- c. The total price of our Bid in words and figures, excluding any discounts offered below is: *[insert information]*;
- d. The discounts offered and the methodology for their application are: *[insert information]*;
- e. The total bid price includes the cost of all taxes, such as, but not limited to: *[specify the applicable taxes, e.g. (i) value added tax (VAT), (ii) income tax, (iii) local taxes, and (iv) other fiscal levies and duties]*, which are itemized herein and reflected in the detailed estimates,
- f. Our Bid shall be valid within the period stated in the PBDs, and it shall remain binding upon us at any time before the expiration of that period;
- g. If our Bid is accepted, we commit to obtain a Performance Security in the amount of *[insert percentage amount]* percent of the Contract Price for the due performance of the Contract, or a Performance Securing Declaration in lieu of the allowable forms of Performance Security, subject to the terms and conditions of issued GPPB guidelines for this purpose;
- h. We are not participating, as Bidders, in more than one Bid in this bidding process, other than alternative offers in accordance with the Bidding Documents;
- i. We understand that this Bid, together with your written acceptance thereof included in your notification of award, shall constitute a binding contract between us, until a formal Contract is prepared and executed; and

j. We understand that you are not bound to accept the Lowest Calculated Bid or any other Bid that you may receive.

k. We likewise certify/confirm that the undersigned, is the duly authorized representative of the bidder, and granted full power and authority to do, execute and perform any and all acts necessary to participate, submit the bid, and to sign and execute the ensuing contract for the [Name of Project] of the [Name of the Procuring Entity].

l. We acknowledge that failure to sign each and every page of this Bid Form, including the Bill of Quantities, shall be a ground for the rejection of our bid.

Name:

Legal Capacity: _____

Signature: _____

Duly authorized to sign the Bid for and behalf of: _____

Date: _____

