

PA SPECIFICATION

QM SPEC NR IC-21PAPBDU
w/ AMENDMENT 2

02 JUN 2022

Interim

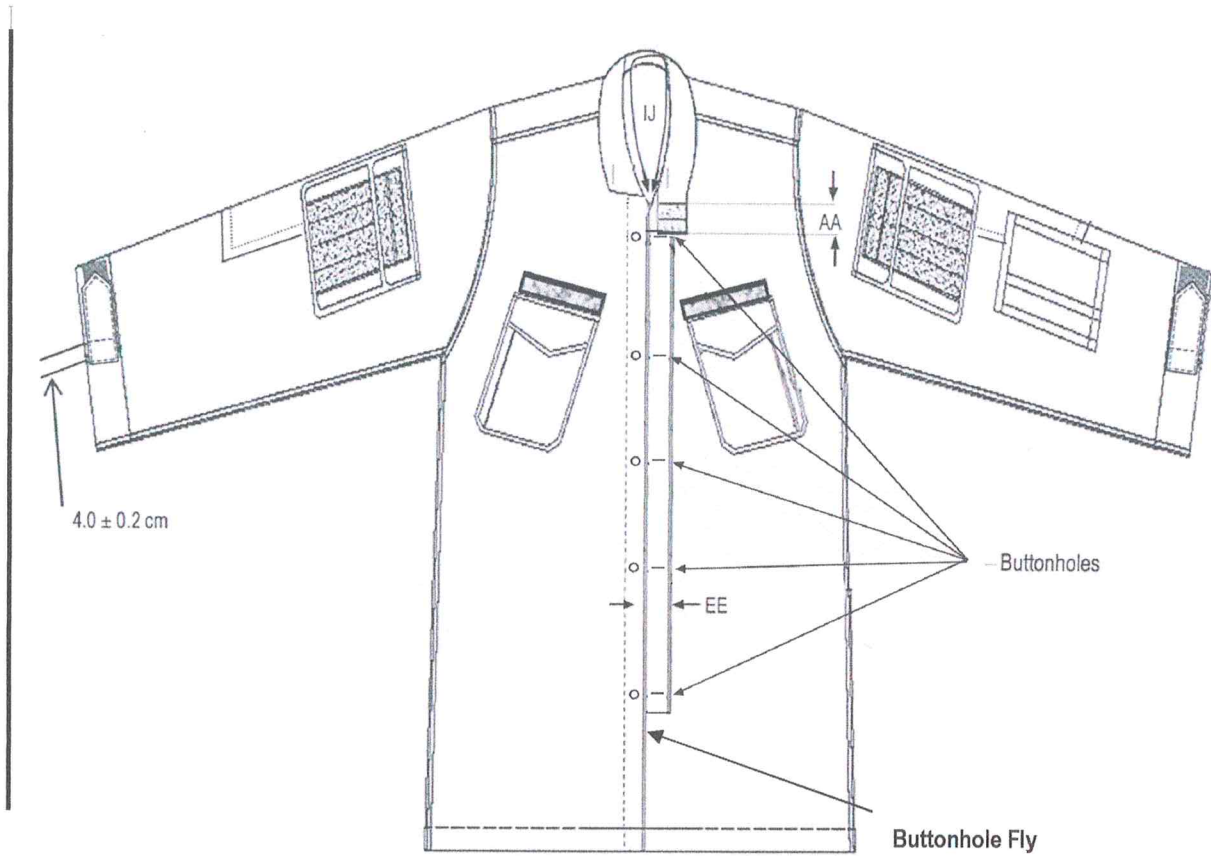

FRONT VIEW

602

PA SPECIFICATION

QM SPEC NR IC-21PAPBDU
w/ AMENDMENT 2

02 JUN 2022

Interim

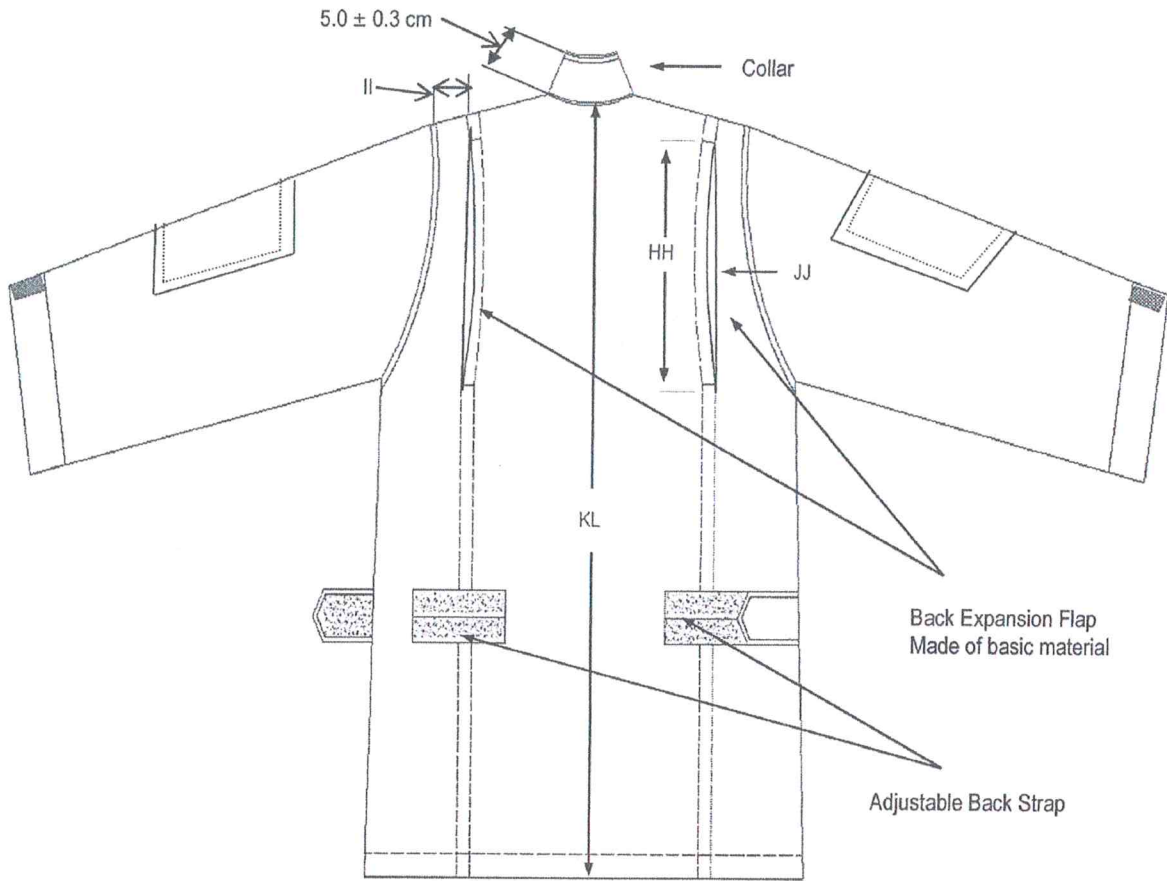

BACK VIEW

60

PA SPECIFICATION

QM SPEC NR IC-21PAPBDU
w/ AMENDMENT 2

02 JUN 2022

Interim

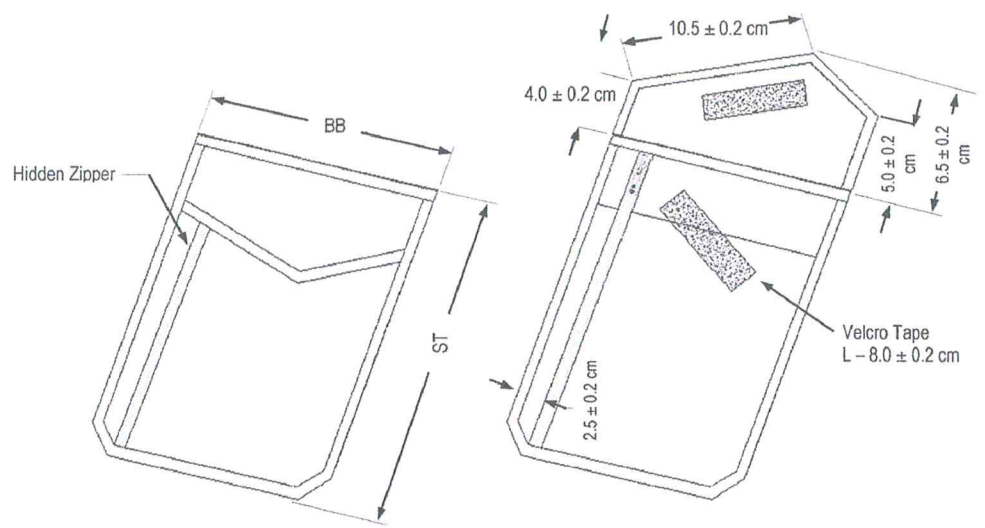

BREAST POCKET WITH FLAP

BREAST POCKET WITH FLAP OPEN

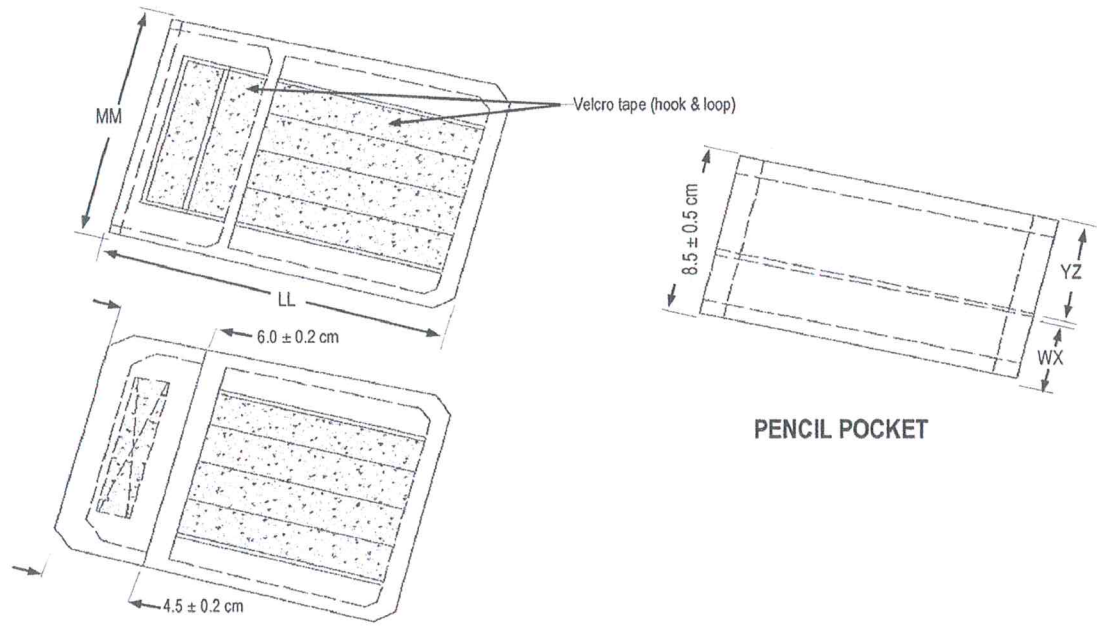

SLEEVE POCKET WITH FLAP OPEN

PENCIL POCKET

60

✓

PA SPECIFICATION

QM SPEC NR IC-21PAPBDU
w/ AMENDMENT 2

U 2 JUN 2022

Interim

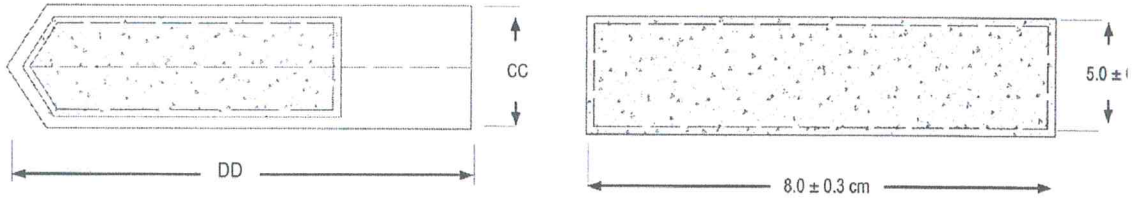

CUFF WITH VELCRO TAPE

VELCRO TAPE

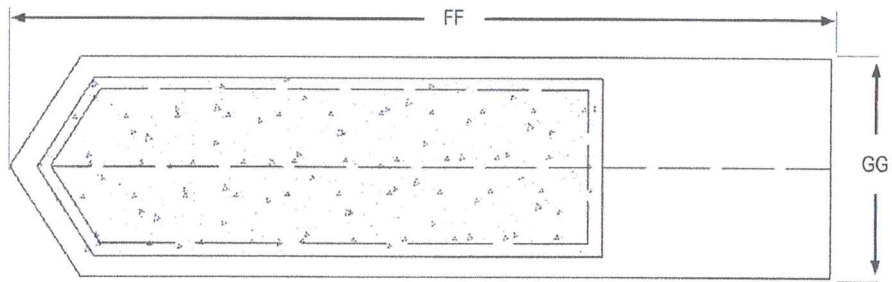

ADJUSTABLE BACK STRAP WITH VELCRO TAPE

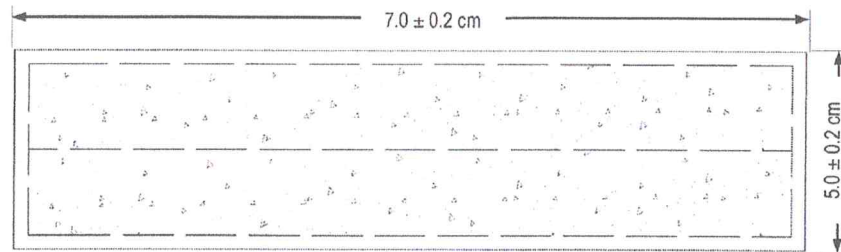

VELCRO TAPE

60

PA SPECIFICATION

QM SPEC NR IC-21PAPBDU
w/ AMENDMENT 2

02 JUN 2022

Interim

TROUSERS

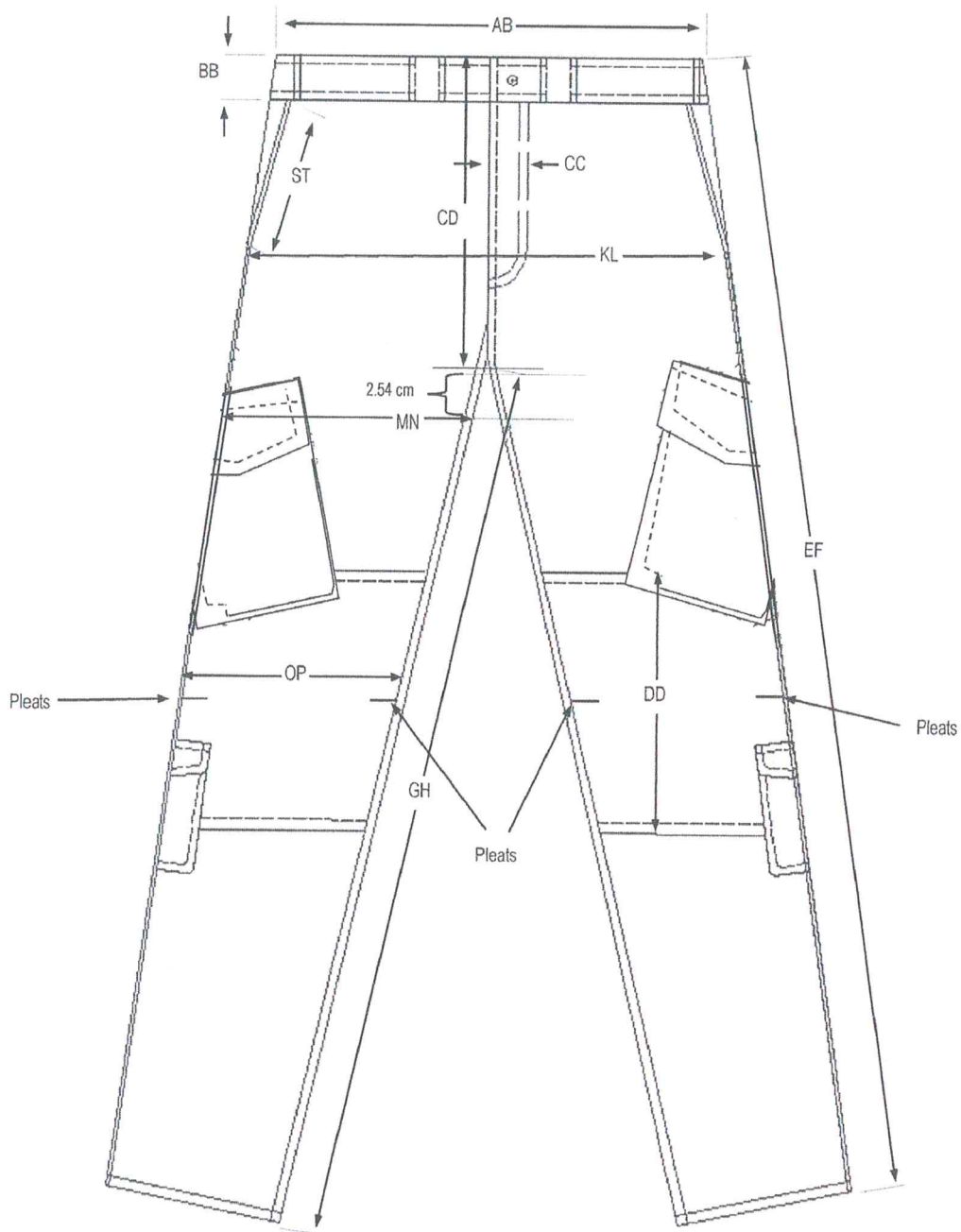

FRONT VIEW



PA SPECIFICATION

QM SPEC NR IC-21PAPBDU
w/ AMENDMENT 2

02 JUN 2022

Interim

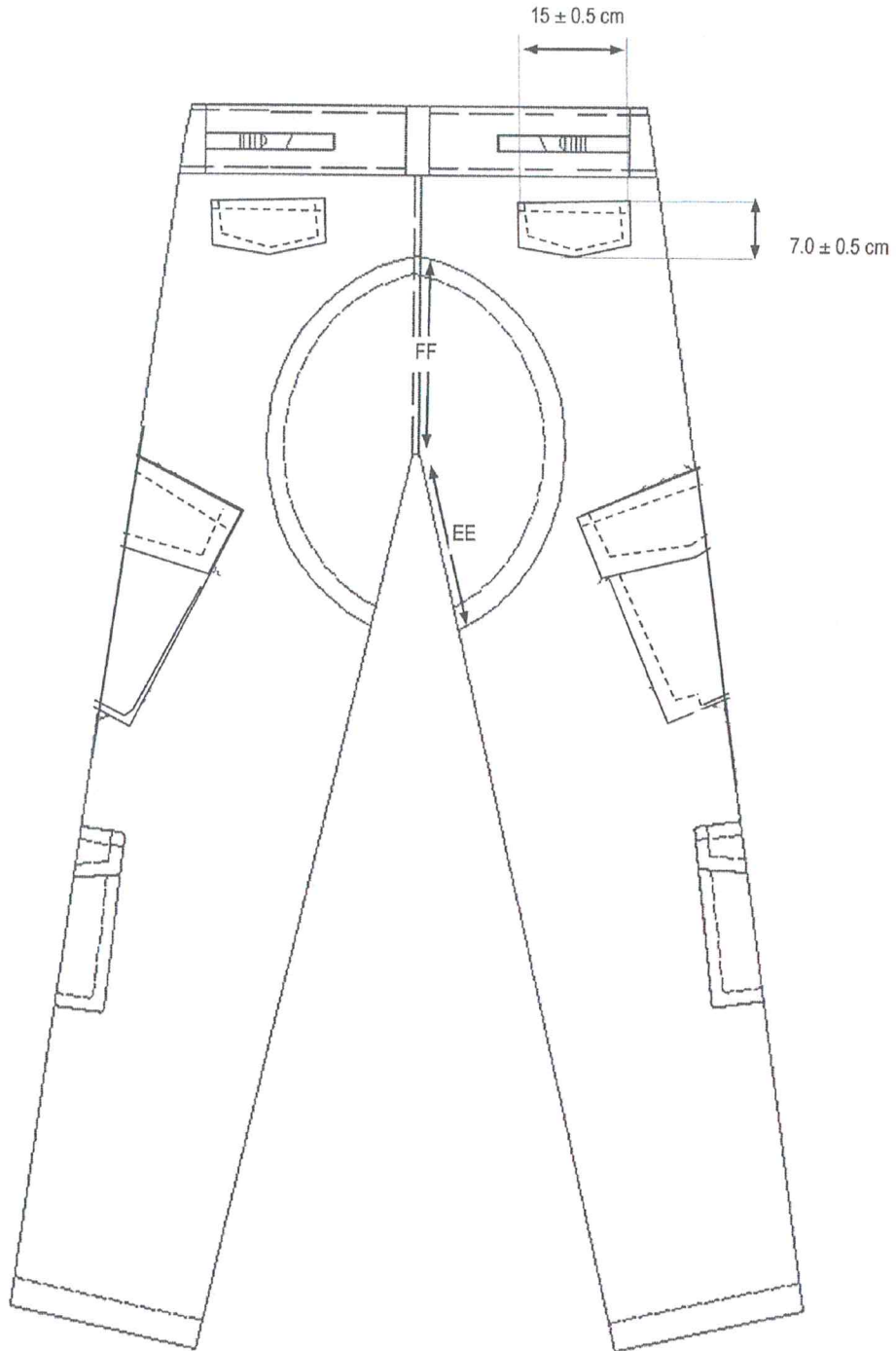

66



PA SPECIFICATION

QM SPEC NR IC-21PAPBDU
w/ AMENDMENT 2

02 JUN 2022

Interim

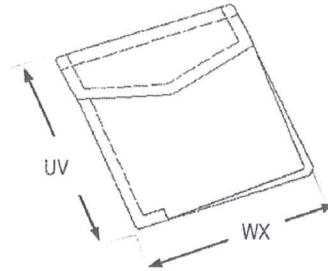
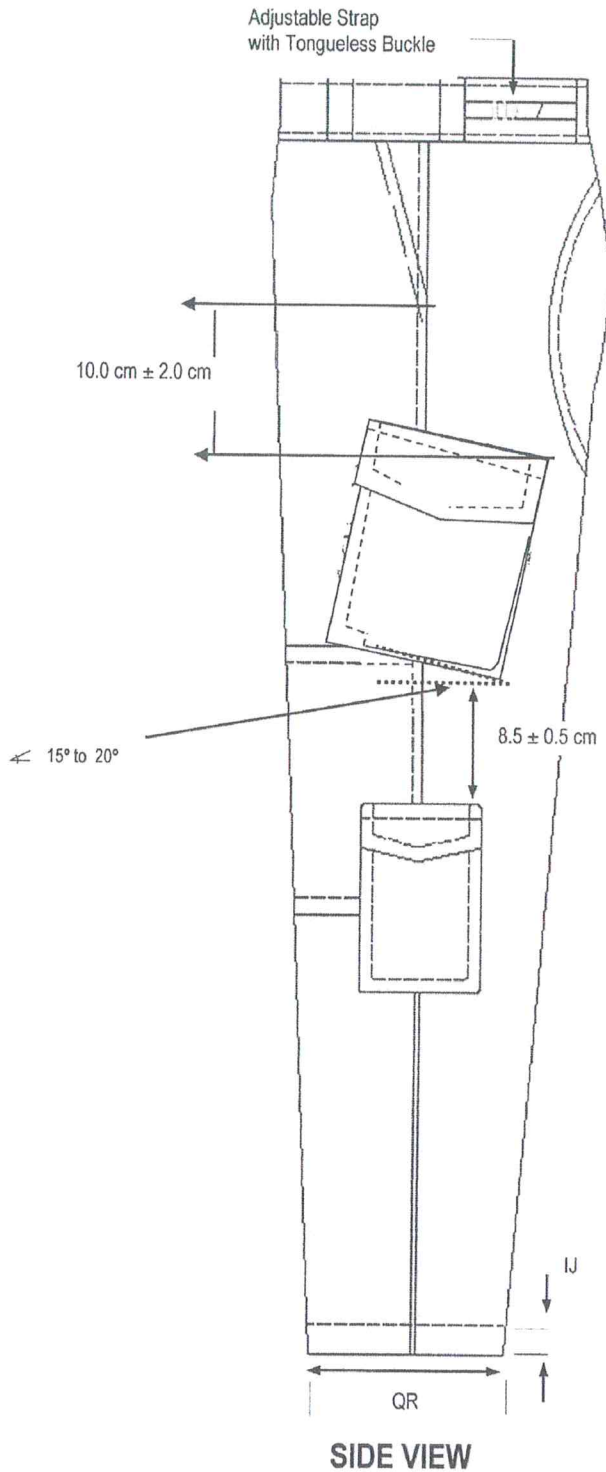

Thigh Pocket with Flap Closed

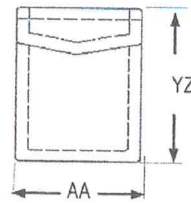

Lower Pocket with Flap Closed

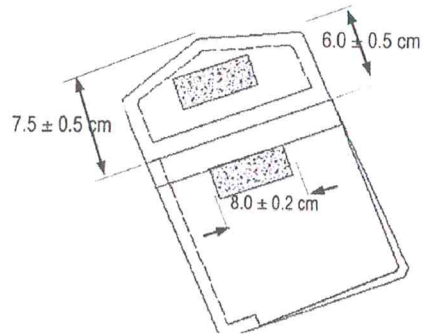

Thigh Pocket with Flap Open

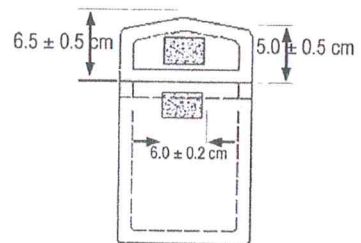

Lower Pocket with Flap Open

6a

PA SPECIFICATION

QM SPEC NR IC-21PAPBDU
w/ AMENDMENT 2

02 JUN 2022

Interim

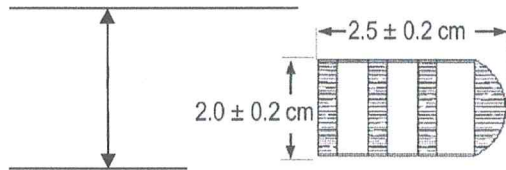

DOUBLE BAR TONGUELESS BUCKLE

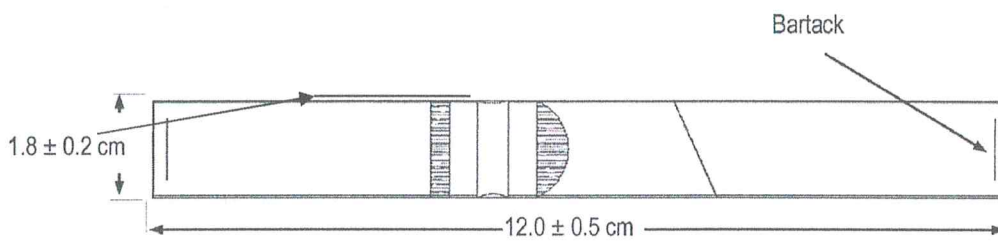

ADJUSTABLE STRAP WITH DOUBLE BAR TONGUELESS BUCKLE

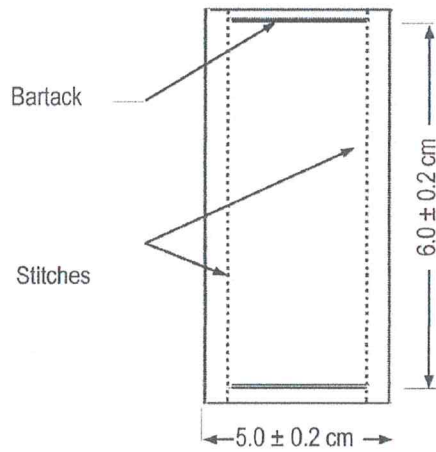

BELT LOOP

60

PA SPECIFICATION

QM SPEC NR IC-21PAPBDU
w/ AMENDMENT 2

02 JUN 2022

Interim

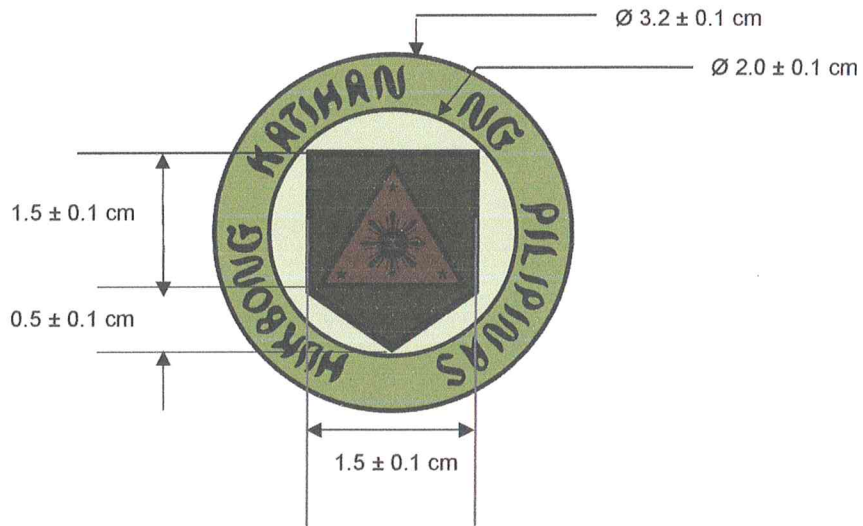
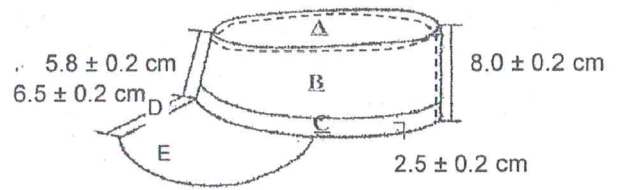
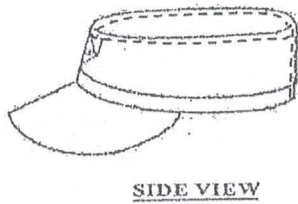
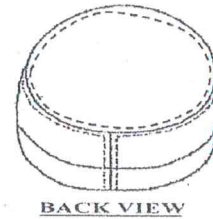
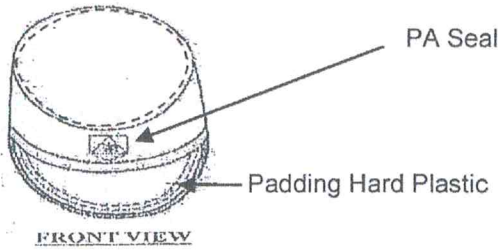

FIGURE 3

60

